

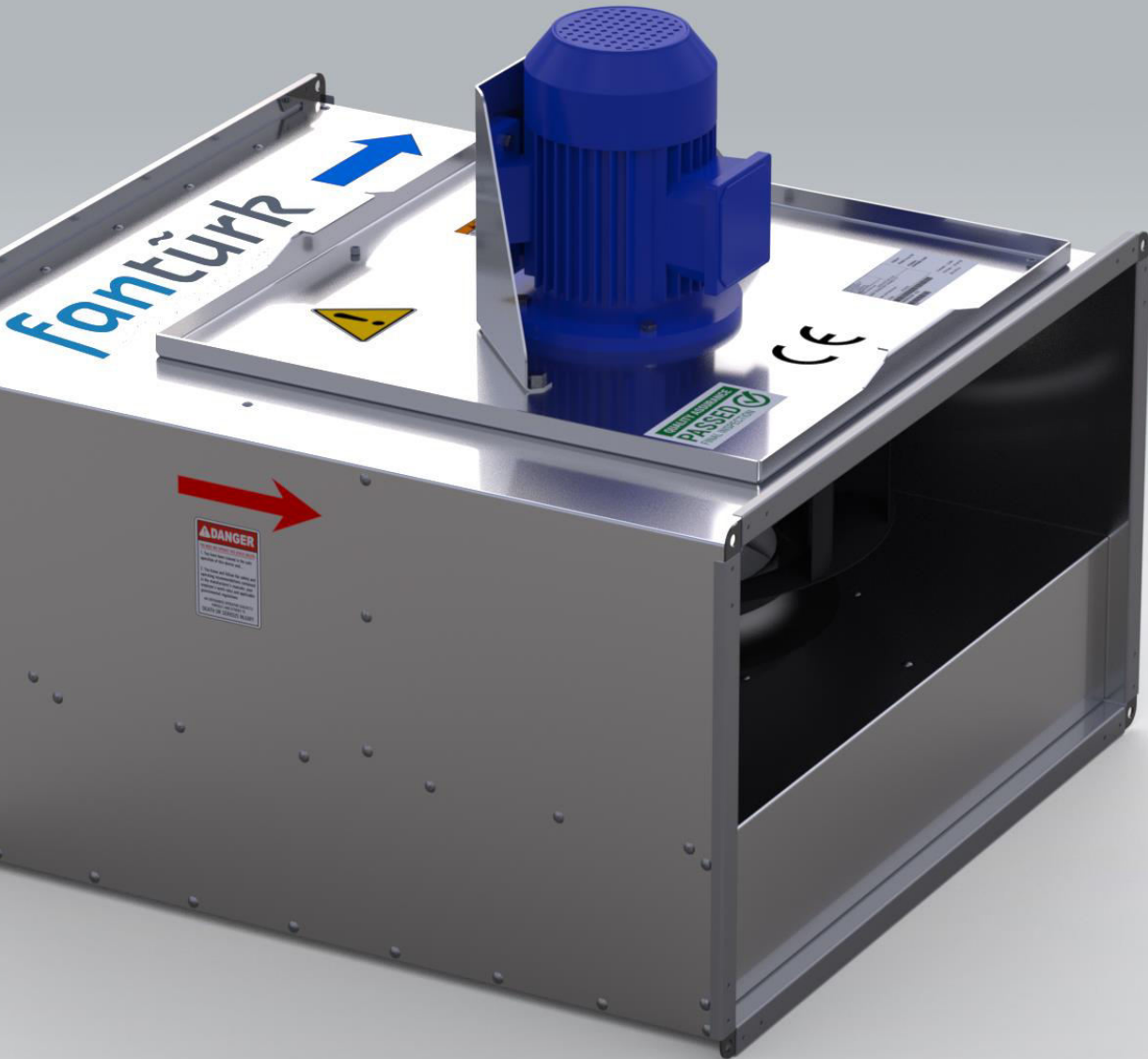

# ***Product Catalogue***



*D-KTF  
External Driven  
Rectangular Duct  
Type In-Line Fan*



## Technical Specifications

# EXTERNAL DRIVEN RECTANGULAR DUCT TYPE IN-LINE FAN

D-KTF series rectangular duct type radial fans; They are the ideal fans for ducted ventilation systems where high air flow and high pressure are required. Thanks to their compact construction, they can be installed directly in the air ducts without the need for large bends and transducers in any position required. D-KTF series in-line fans are the ideal choice for high performance and trouble-free operation.

Made of high quality corrosion resistant galvanized steel. Fans are radial fans with backward curved blades. Motors can be single or three phase and has IP55 and Class F insulation. Due to the fact that the motor is out of the air flow, it is protected from the factors that will damage the motor or hot air. This method provides 120 ° C continuous operation. Speed controller is optional for all models.

Can be manufactured with Ex-Proof feature if requested.

### Usage Areas

Can be used in all kinds of industrial, office, kitchen, hotel, residential and parking ventilation systems where the fluid is hot or corrosive.

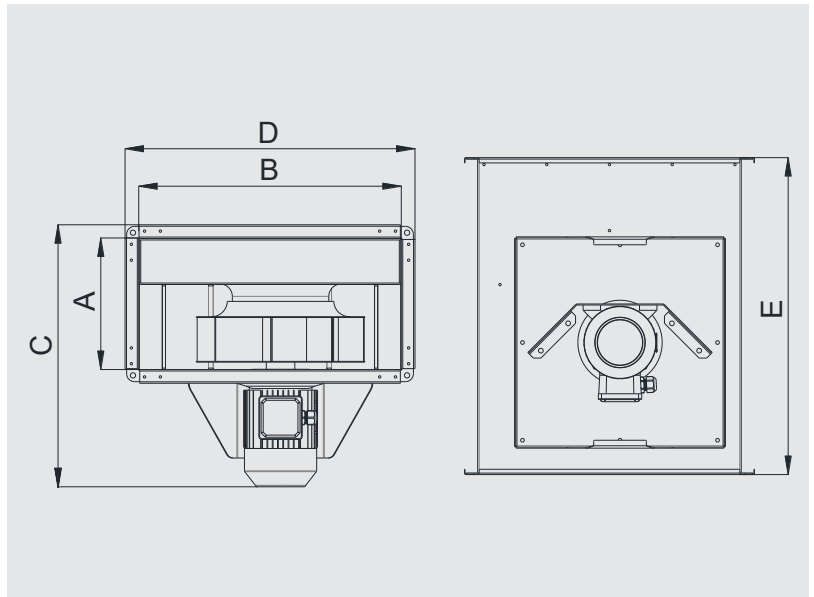

MODEL	A	B	C	D	E	VOLTAGE	FREQUENCY	POWER	CURRENT	MOTOR SPEED	AIR FLOW RATE	SOUND LEVEL	WEIGHT
	mm	mm	mm	mm	mm	V	Hz	kW	A	rpm	m <sup>3</sup> /h	dBA	kg
D-KTF 280	250	500	469	550	650	380	50	0,18	0,6	1340	1150	48	28
D-KTF 315	250	500	495	550	600	380	50	0,25	0,8	1380	2000	53	32
D-KTF 355	300	600	545	650	750	380	50	0,37	1,2	1390	2500	55	34
D-KTF 400	400	700	665	750	800	380	50	0,55	1,6	1385	3500	56	38
D-KTF 450	400	700	665	750	800	380	50	0,75	2	1370	5000	58	49
D-KTF 500	500	800	765	850	900	380	50	1,1	2,6	1380	7000	61	63
D-KTF 560	500	1000	790	1050	1050	380	50	1,5	3,5	1385	9800	64	74

## Performance Curves

### D-KTF 280

Voltage 380 V  
Frequency 50 Hz  
Motor Power 0,18 kW  
Motor Speed 1340 rpm  
Sound Pressure Level 48 dBA  
Weight 28 kg

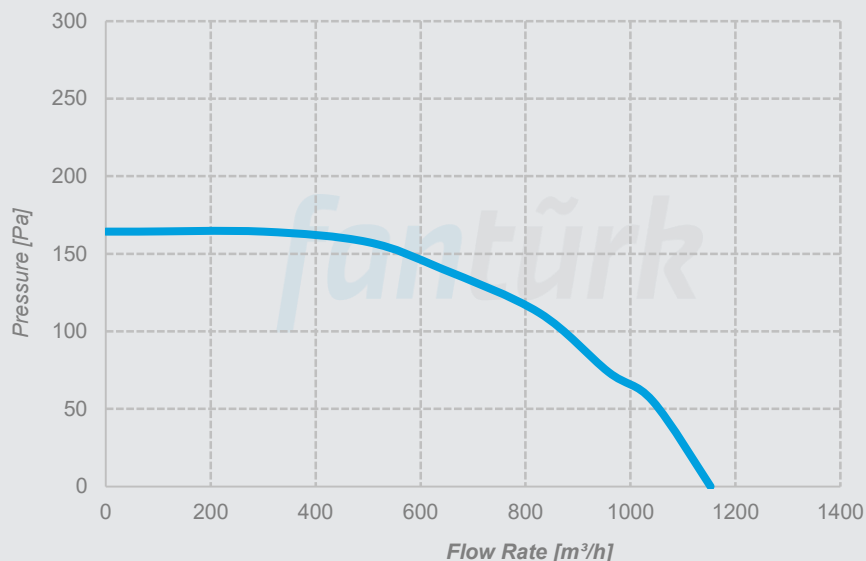

### D-KTF 315

Voltage 380 V  
Frequency 50 Hz  
Motor Power 0,25 kW  
Motor Speed 1380 rpm  
Sound Pressure Level 53 dBA  
Weight 32 kg

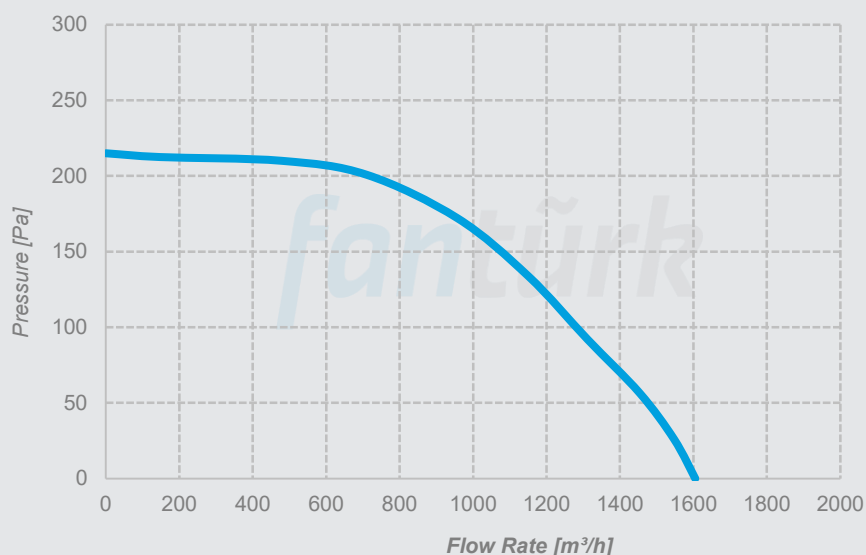

### D-KTF 355

Voltage 380 V  
Frequency 50 Hz  
Motor Power 0,37 kW  
Motor Speed 1390 rpm  
Sound Pressure Level 55 dBA  
Weight 34 kg

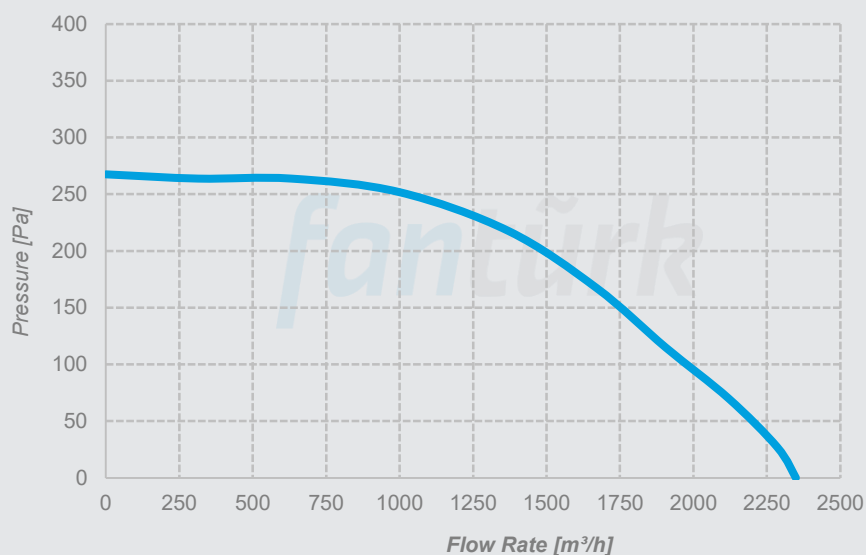

## Performance Curves

### D-KTF 400

Voltage 380 V  
Frequency 50 Hz  
Motor Power 0,55 kW  
Motor Speed 1340 rpm  
Sound Pressure Level 56 dBA  
Weight 38 kg

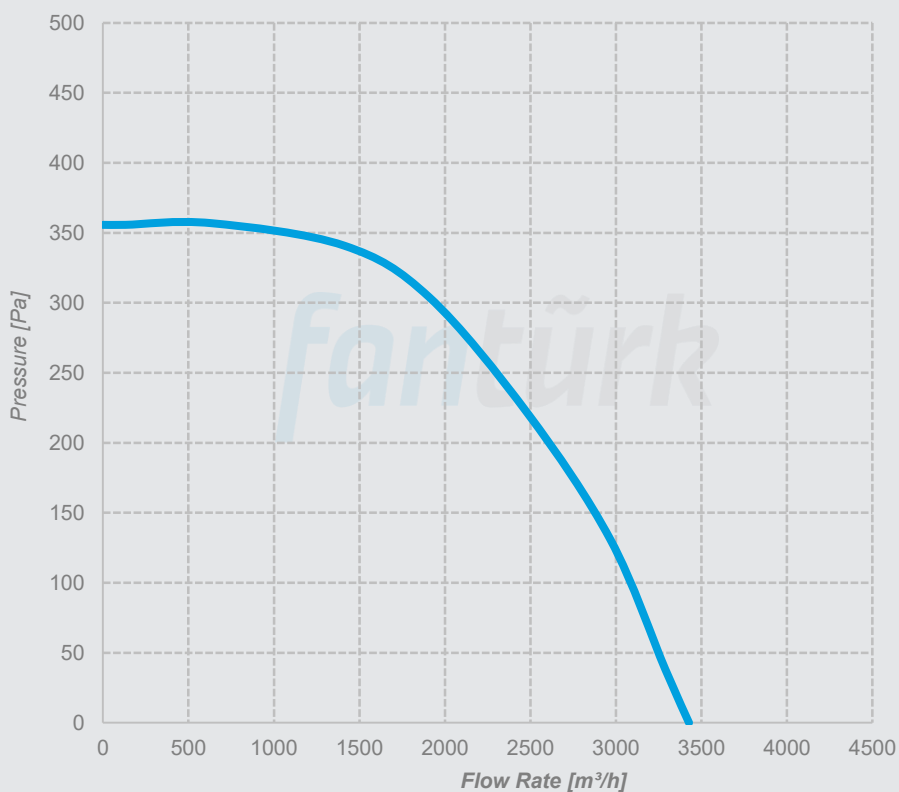

### D-KTF 450

Voltage 380 V  
Frequency 50 Hz  
Motor Power 0,75 kW  
Motor Speed 1370 rpm  
Sound Pressure Level 58 dBA  
Weight 49 kg

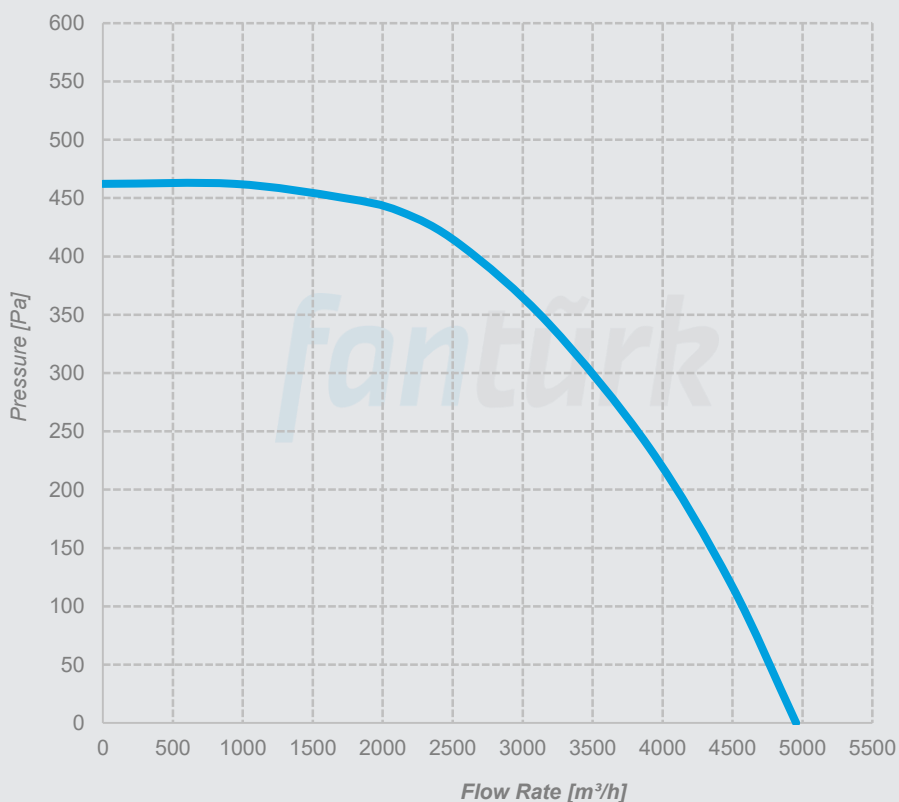

## Performance Curves

### D-KTF 500

Voltage 380 V  
Frequency 50 Hz  
Motor Power 1,1 kW  
Motor Speed 1380 rpm  
Sound Pressure Level 61 dBA  
Weight 63 kg

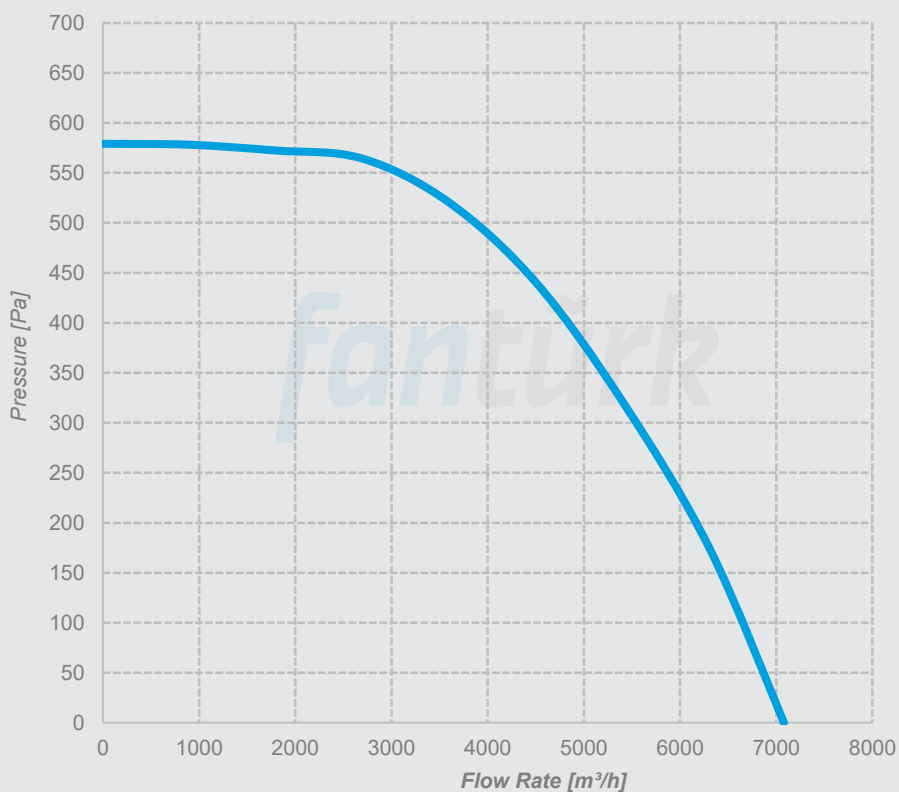

### D-KTF 560

Voltage 380 V  
Frequency 50 Hz  
Motor Power 1,5 kW  
Motor Speed 1385 rpm  
Sound Pressure Level 64 dBA  
Weight 74 kg

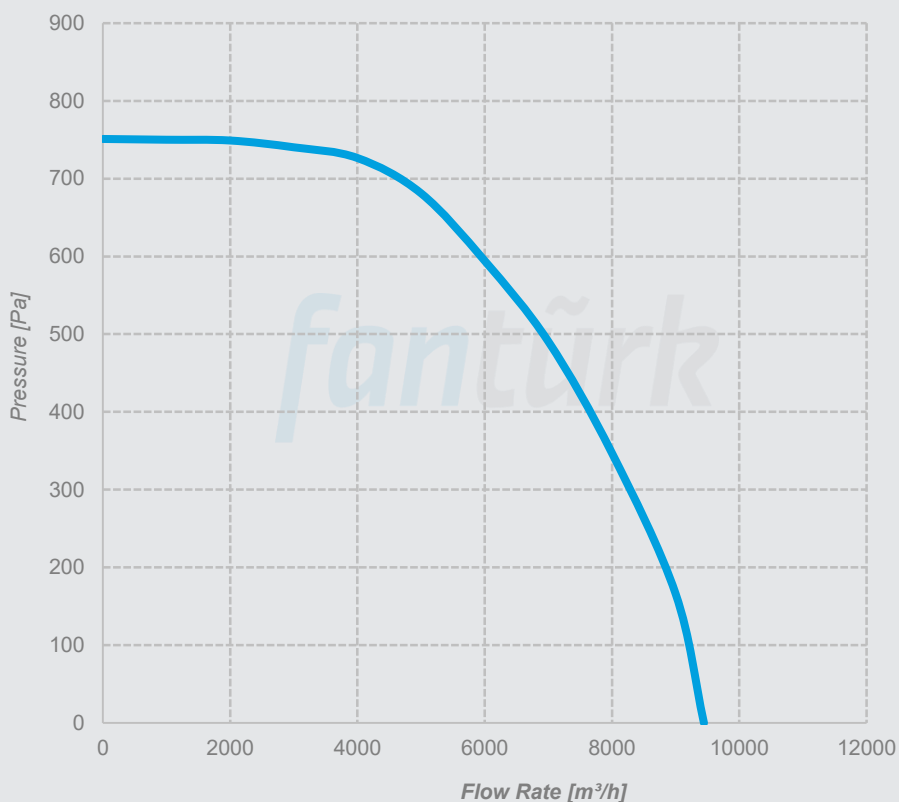

*Minarelicavus OSB District 202. Street No: 19 Nilüfer/Bursa Turkey  
T: 90(224)482 50 95 E: info@fanturk.com.tr*

*fanturk.com.tr*