

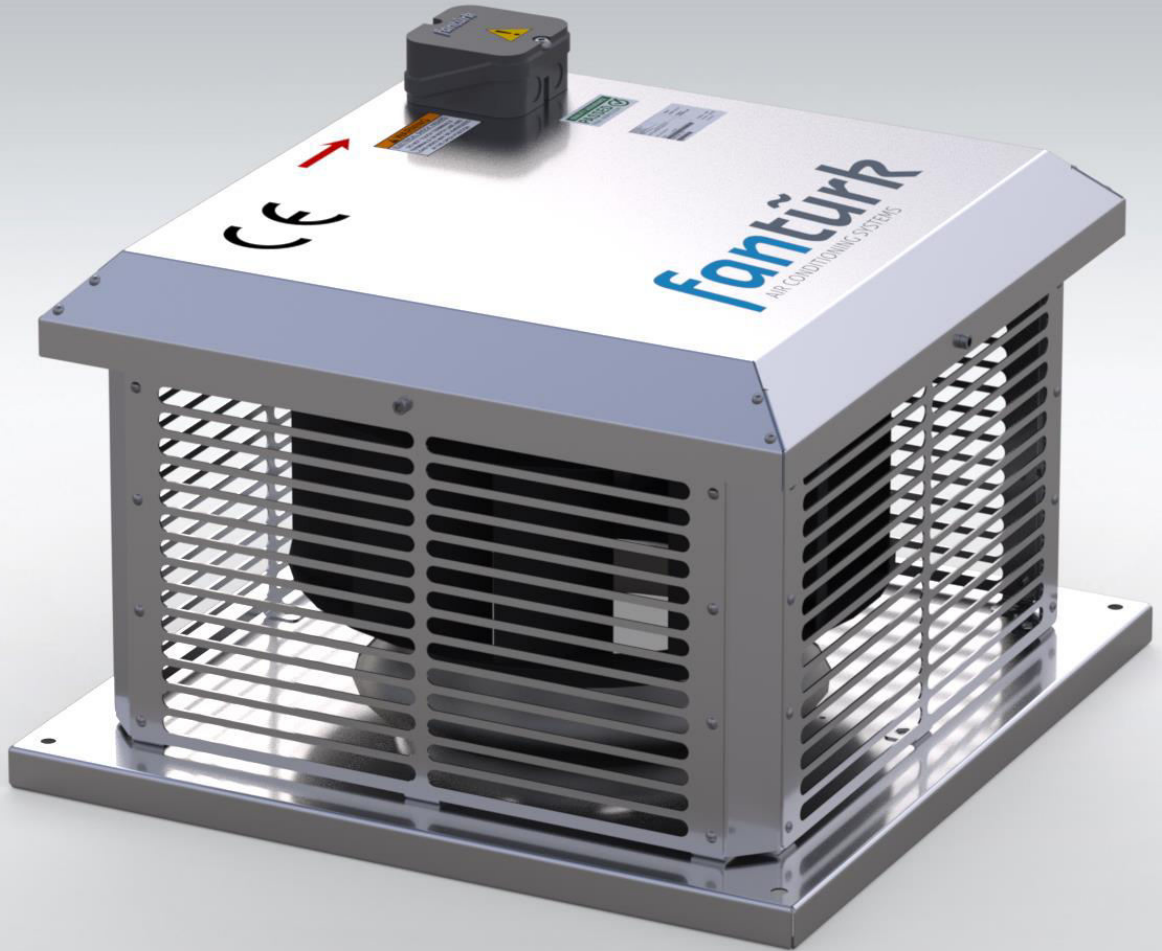

Product Catalogue



ÇTF
Roof Type
Radial Fan



Technical Specifications

ROOF TYPE RADIAL FAN

ÇTF (230V) series roof type radial fans; are the ideal fans for roof installation in ventilation systems where high air flow and high pressure are required. They have high performance and trouble-free operation specifications.

Made of high quality corrosion resistant galvanized steel. Fans are radial fans with backward curved blades. Motors are single phase and has IP55 and Class F insulation. Speed controller is optional for all models..

Usage Areas

Can be used in all kinds of industrial building, office, kitchen and residential building ventilation systems where compact solutions are needed.

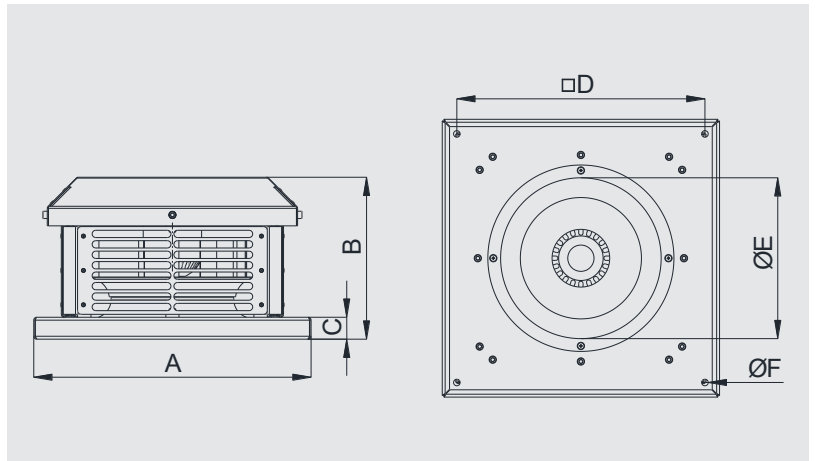

MODEL	A	B	C	D	E	F	VOLTAGE	FREQUENCY	POWER	CURRENT	CAPACITOR	MOTOR SPEED	AIR FLOW RATE	SOUND LEVEL	WEIGHT
	mm	mm	mm	mm	mm	mm	V	Hz	W	A	µf	rpm	m ³ /h	dBA	kg
ÇTF-1	320	175	30	280	145	9	230	50	66	0,3	3	2300	540	52	6,5
ÇTF-2	350	190	30	310	190	9	230	50	100	0,47	3	2580	800	56	8,3
ÇTF-3	360	210	30	320	170	9	230	50	150	0,65	4	2680	1020	58	8,5
ÇTF-4	380	220	30	340	220	9	230	50	200	0,9	6	2650	1520	58	9,7
ÇTF-5	410	220	30	370	220	9	230	50	250	1,1	8	2500	1840	60	11
ÇTF-6	500	310	30	460	270	9	230	50	210	1	8	1400	2520	62	17
ÇTF-7	570	365	30	530	310	11	230	50	500	1,8	12	1380	4100	64	28
ÇTF-8	630	365	30	590	310	11	230	50	800	3,7	16	1350	5600	65	31

Performance Curves

ÇTF-1

Voltage 230 V
Frequency 50 Hz
Current 66 W
Current 0,3 A
Capacitor 3 μ f
Motor Speed 2300 rpm
Flow Rate 540 m³/h
Sound Pressure Level 52 dBA
Weight 6,5 kg

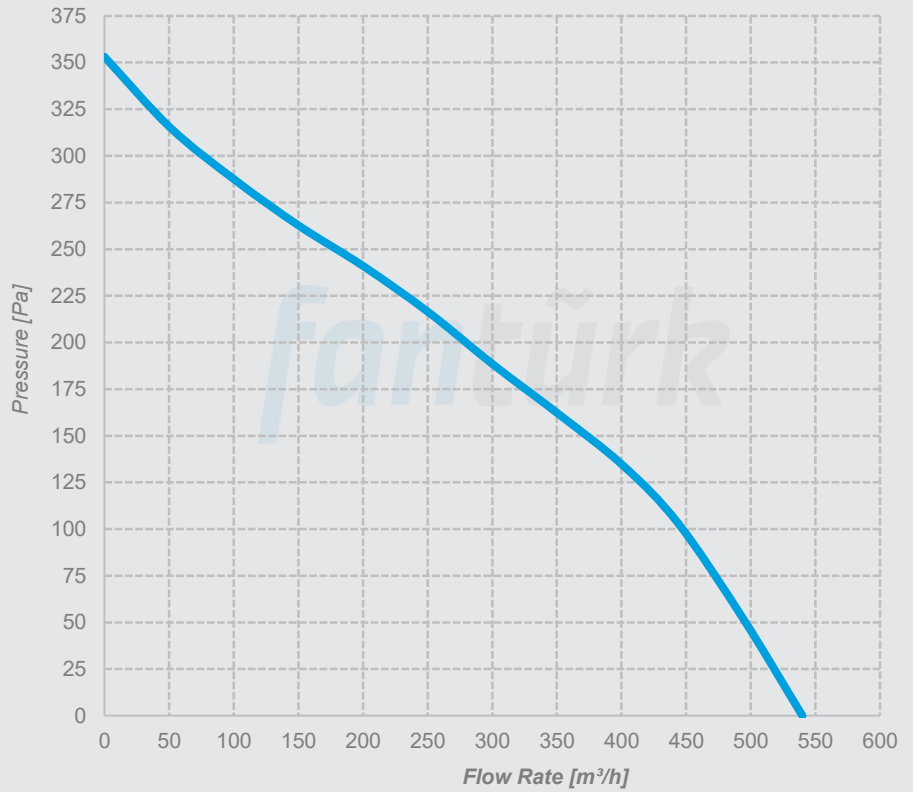

ÇTF-2

Voltage 230 V
Frequency 50 Hz
Current 100 W
Current 0,47 A
Capacitor 3 μ f
Motor Speed 2580 rpm
Flow Rate 800 m³/h
Sound Pressure Level 56 dBA
Weight 8,3 kg

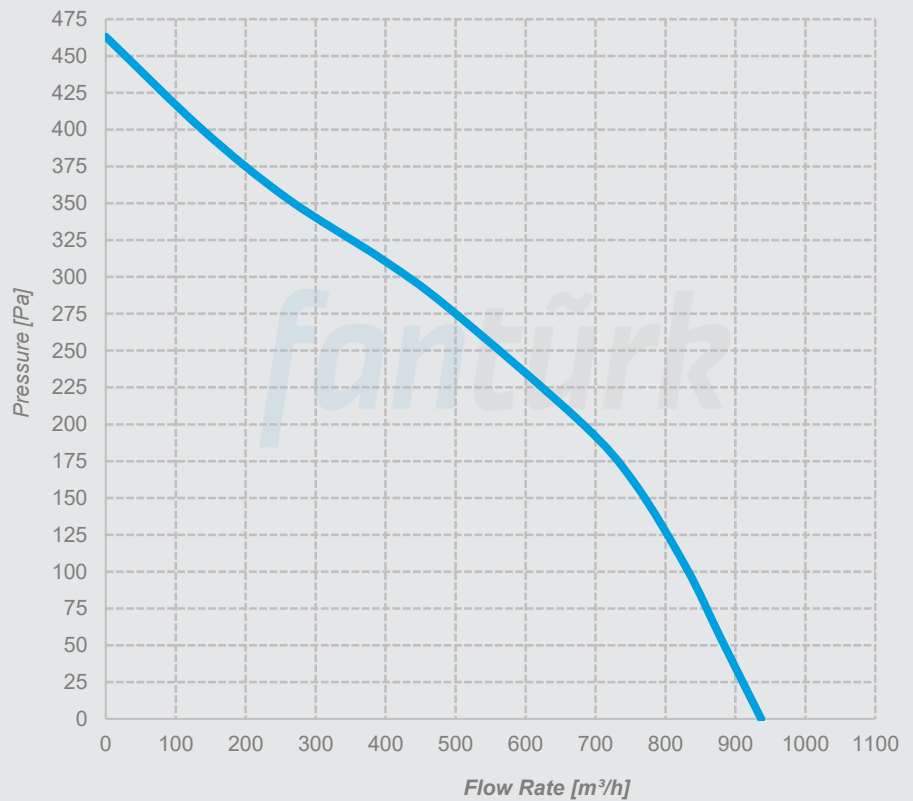

Performance Curves

ÇTF-3

Voltage 230 V
Frequency 50 Hz
Current 150 W
Current 0,65 A
Capacitor 4 μ f
Motor Speed 2680 rpm
Flow Rate 1020m³/h
Sound Pressure Level 58 dBA
Weight 8,5 kg

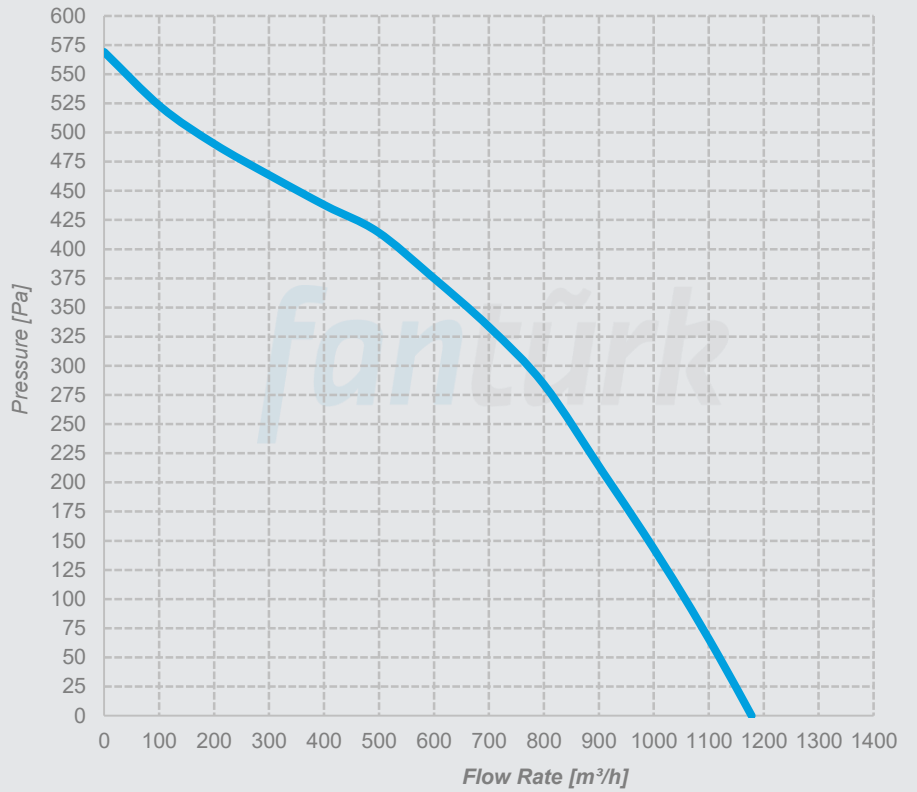

ÇTF-4

Voltage 230 V
Frequency 50 Hz
Current 200 W
Current 0,9 A
Capacitor 6 μ f
Motor Speed 2650 rpm
Flow Rate 1520 m³/h
Sound Pressure Level 58 dBA
Weight 9,7 kg

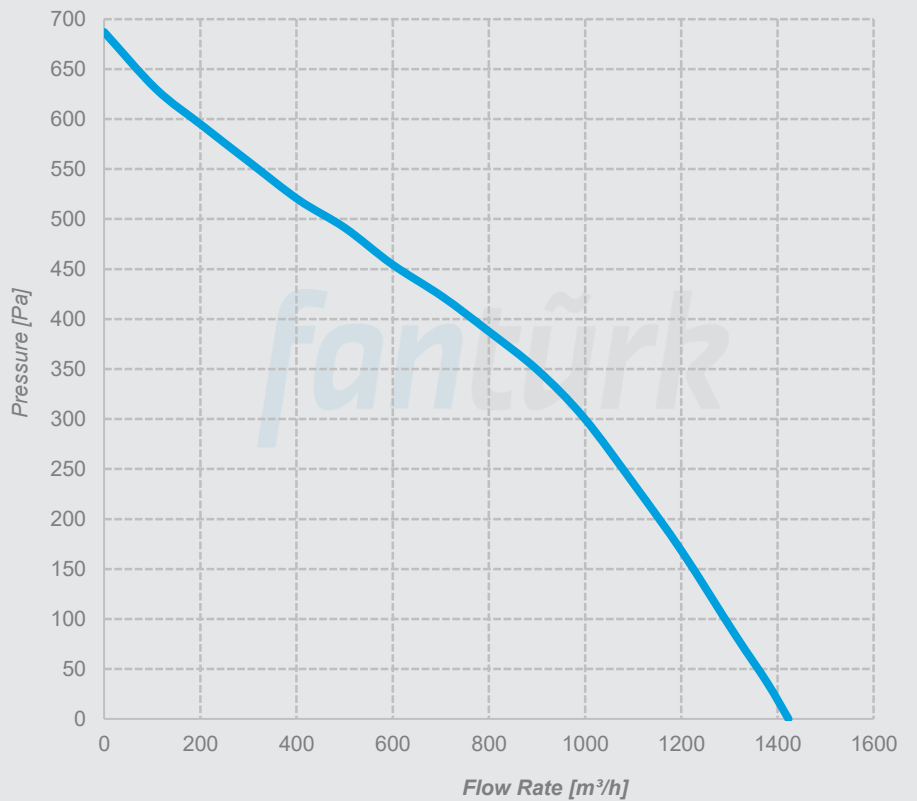

Performance Curves

ÇTF-5

Voltage 230 V
Frequency 50 Hz
Current 250 W
Current 1,1 A
Capacitor 8 μ f
Motor Speed 2500 rpm
Flow Rate 1840 m³/h
Sound Pressure Level 60 dBA
Weight 11 kg

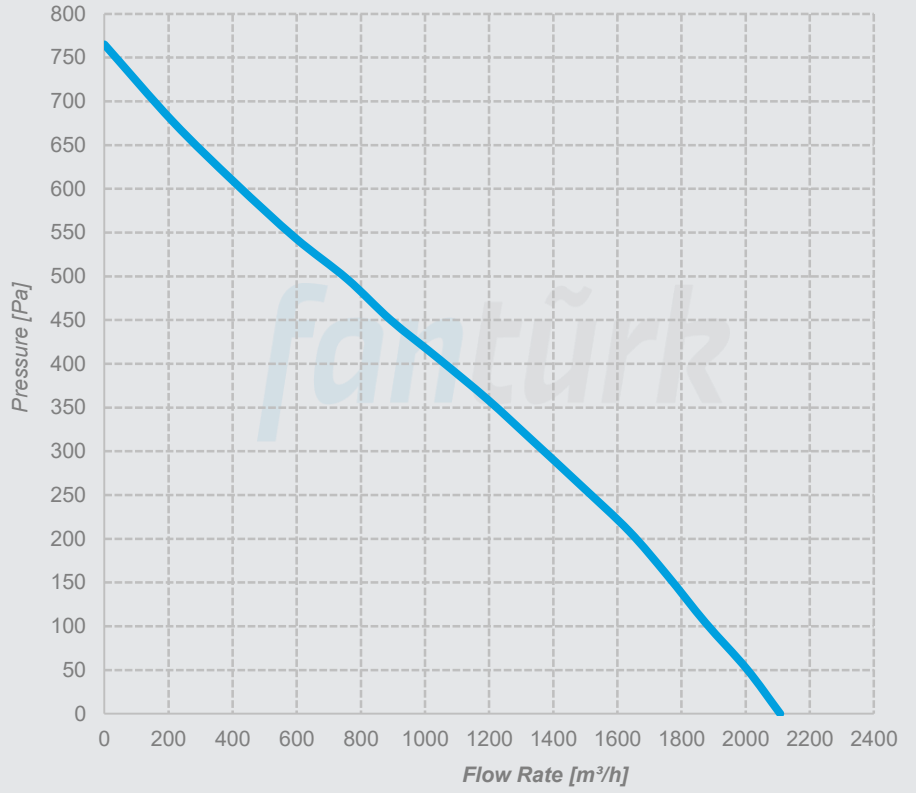

ÇTF-6

Voltage 230 V
Frequency 50 Hz
Current 210 W
Current 1 A
Capacitor 8 μ f
Motor Speed 1400 rpm
Flow Rate 2520 m³/h
Sound Pressure Level 62 dBA
Weight 17 kg

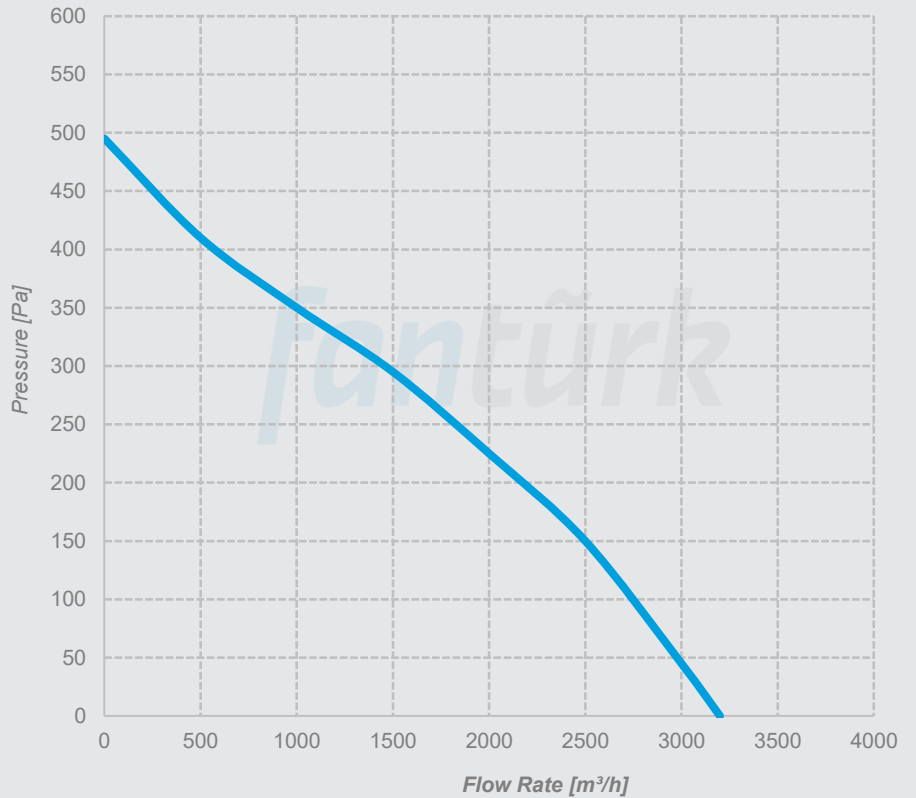

Performance Curves

ÇTF-7

Voltage 230 V
Frequency 50 Hz
Current 500 W
Current 1,8 A
Capacitor 12 μ f
Motor Speed 1380 rpm
Flow Rate 4100 m³/h
Sound Pressure Level 64 dBA
Weight 28 kg

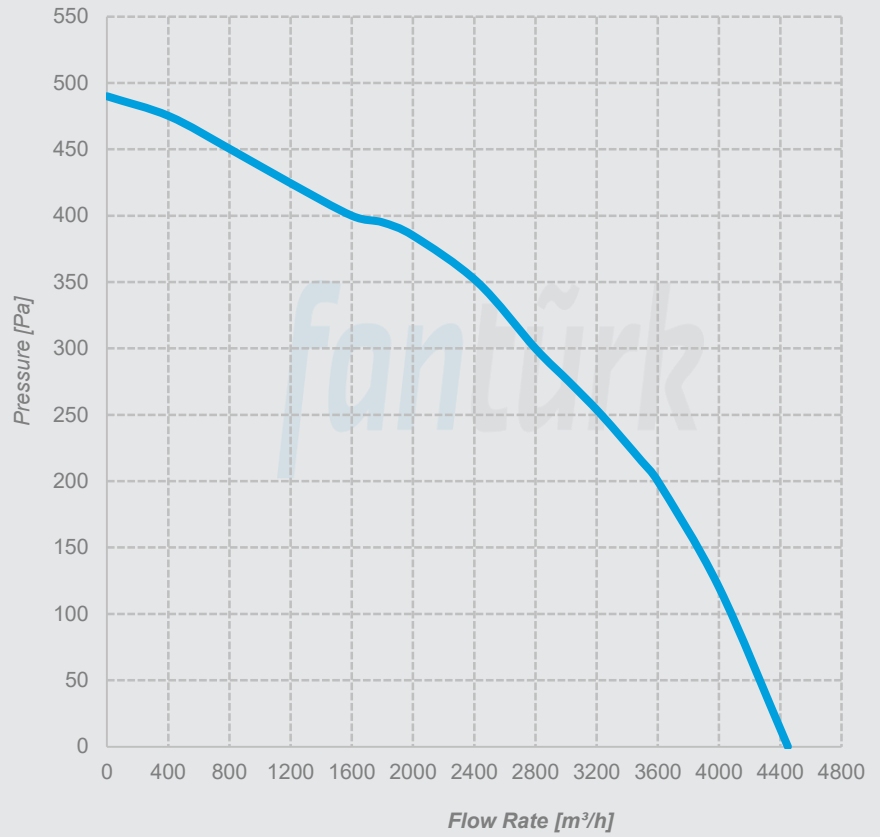

ÇTF-8

Voltage 230 V
Frequency 50 Hz
Current 800 W
Current 3,7 A
Capacitor 16 μ f
Motor Speed 1350 rpm
Flow Rate 5600 m³/h
Sound Pressure Level 65 dBA
Weight 31 kg

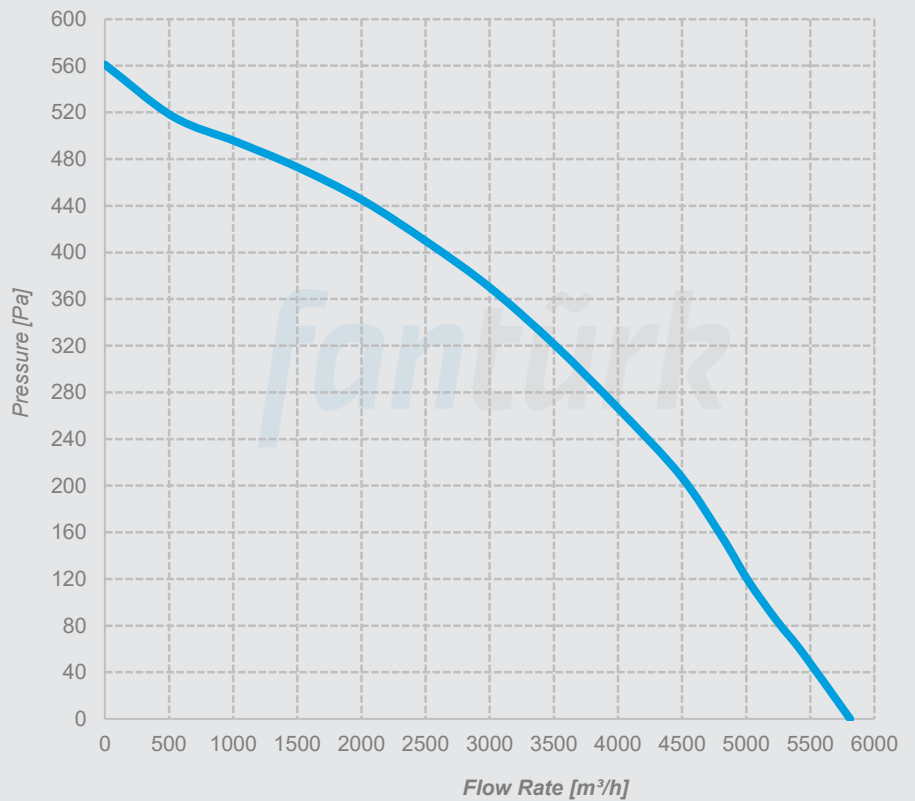

*Minarelicavus OSB District 202. Street No: 19 Nilüfer/Bursa Turkey
T: 90(224)482 50 95 E: info@fanturk.com.tr*

fanturk.com.tr