

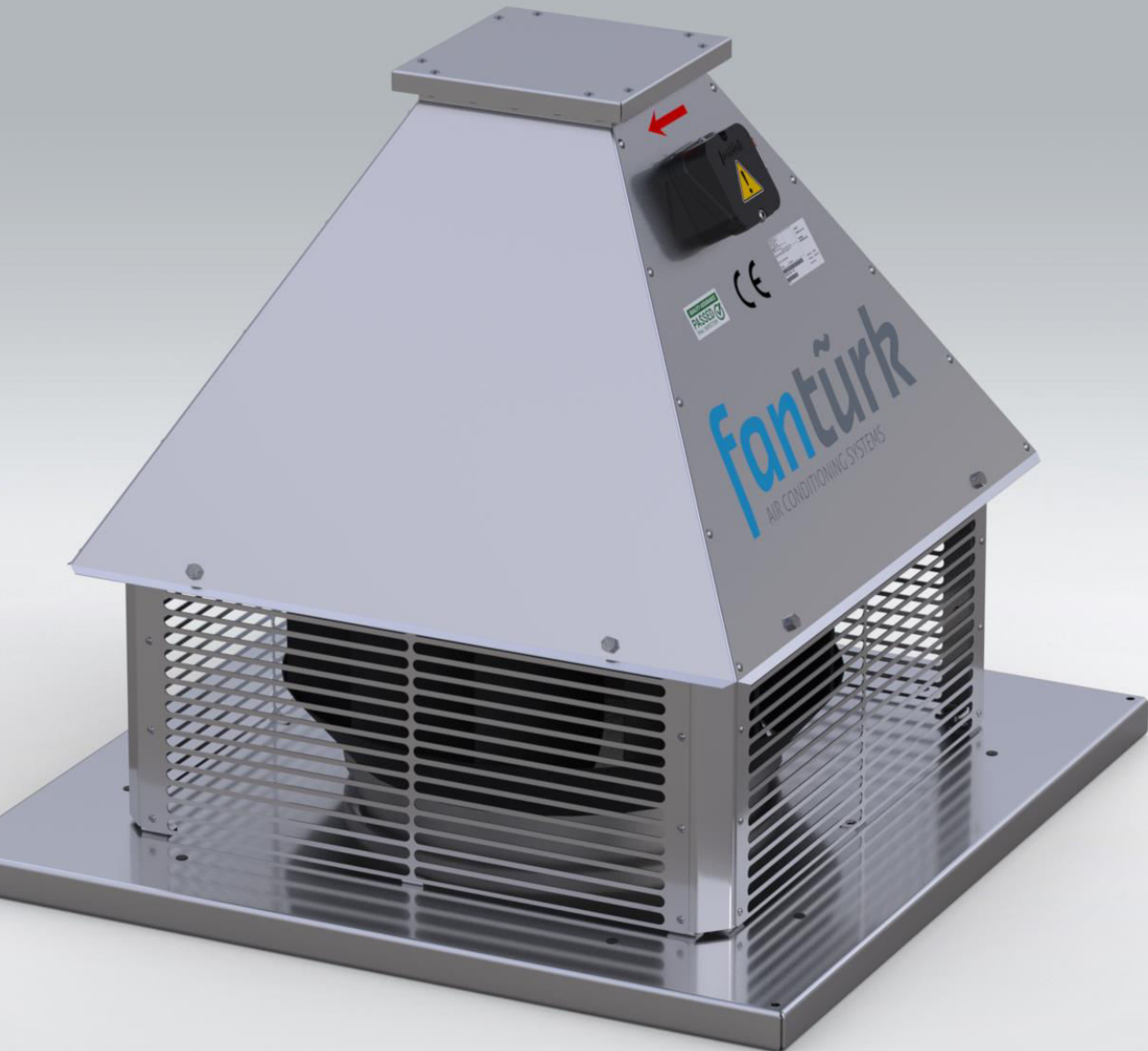

# ***Product Catalogue***



**ÇTF**  
**External Driven**  
**Roof Type**  
**Horizontal Flow**  
**Radial Fan**



## Technical Specifications

# EXTERNAL DRIVEN ROOF TYPE HORIZONTAL FLOW RADIAL FAN

ÇTF (380V) series roof type radial fans; are the ideal fans for roof installation in ventilation systems where high air flow and high pressure are required.

Made of high quality corrosion resistant galvanized steel. Fans are radial fans with backward curved blades. Motors are three-phase and have 4 pole, IP55 and Class F insulation. Due to the fact that the motor is out of the air flow, it is protected from the factors that will damage the motor or hot air. This method provides 120 ° C continuous operation. Frequency controller is optional for all models.

### Usage Areas

Can be used in ventilation systems where the exhaust air is likely to damage the motor, in oily exhaust air from kitchens, and all kinds of industrial buildings, office and residential buildings.

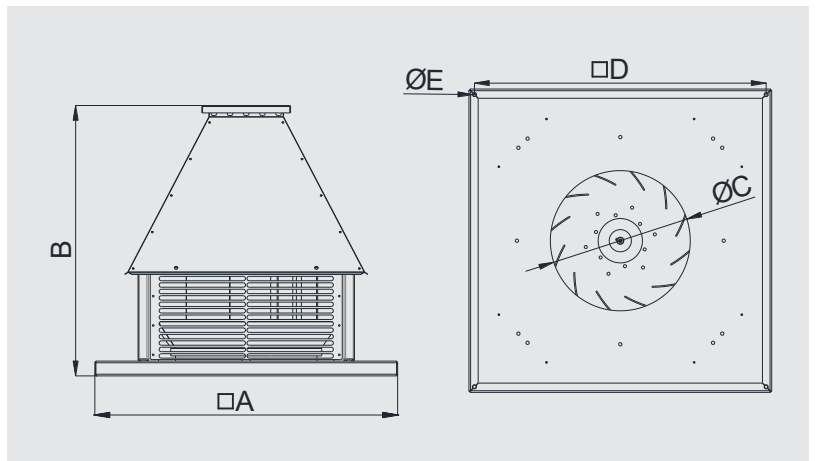

MODEL	A	B	C	D	E	VOLTAGE	FREQUENCY	POWER	CURRENT	MOTOR SPEED	AIR FLOW RATE	PRESSURE	SOUND PRESSURE LEVEL	WEIGHT
	mm	mm	mm	mm	mm	V	Hz	kW	A	rpm	m <sup>3</sup> /h	Pa	dBA	kg
ÇTF 250/0.37	620	583	257	590	9	380	50	0,37	1,2	1360	3000	250	62	55
ÇTF 280/0.55	680	603	260	640	9	380	50	0,55	1,6	1370	4500	250	64	60
ÇTF 315/1.1	720	642	291	690	9	380	50	1,1	2,6	1390	6000	250	67	70
ÇTF 355/2.2	820	751	379	790	9	380	50	2,2	5,2	1420	9000	250	69	80
ÇTF 400/1.1	870	761	395	840	9	380	50	1,1	2,9	930	9000	250	60	85
ÇTF 400/4	870	761	395	840	9	380	50	4	8,2	1430	12000	250	70	105
ÇTF 450/2.2	950	936	430	920	9	380	50	2,2	5,4	950	12000	250	63	130
ÇTF 450/5.5	950	936	430	920	9	380	50	5,5	11,2	1440	15000	250	71	138
ÇTF 450/7.5	950	936	430	920	9	380	50	7,5	15,4	1450	18000	250	72	151

## Performance Curves

### ÇTF 250/0,37

Voltage 380 V  
Frequency 50 Hz  
Motor Power 0,25 kW  
Motor Speed 1360 rpm  
Sound Pressure Level 62 dBA  
Weight 55 kg

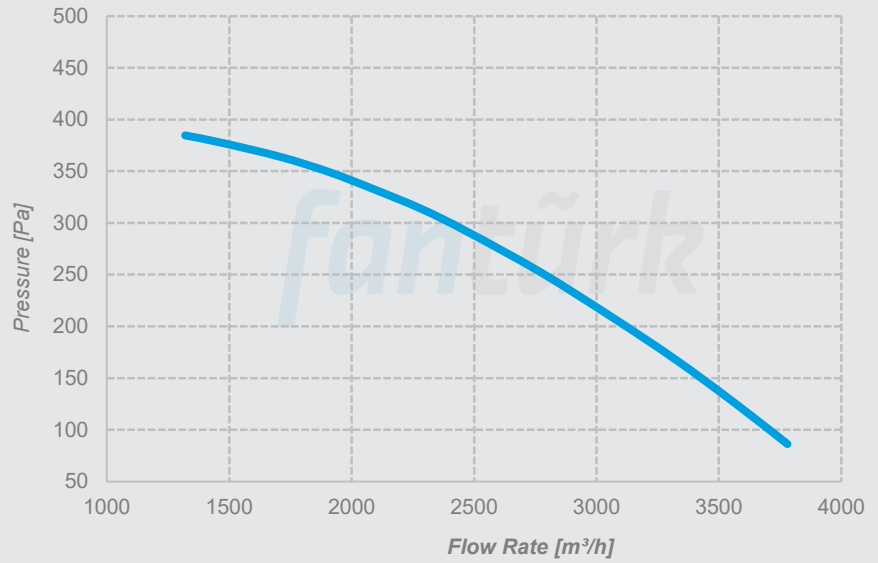

### ÇTF 280/0,55

Voltage 380 V  
Frequency 50 Hz  
Motor Power 0,55 kW  
Motor Speed 1370 rpm  
Sound Pressure Level 64 dBA  
Weight 60 kg

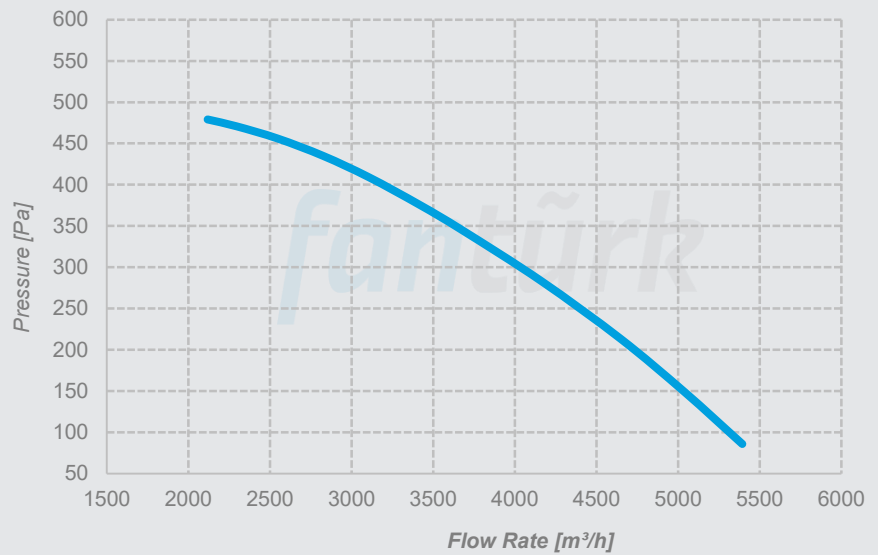

### ÇTF 315/1,1

Voltage 380 V  
Frequency 50 Hz  
Motor Power 1,1 kW  
Motor Speed 1390 rpm  
Sound Pressure Level 67 dBA  
Weight 70 kg

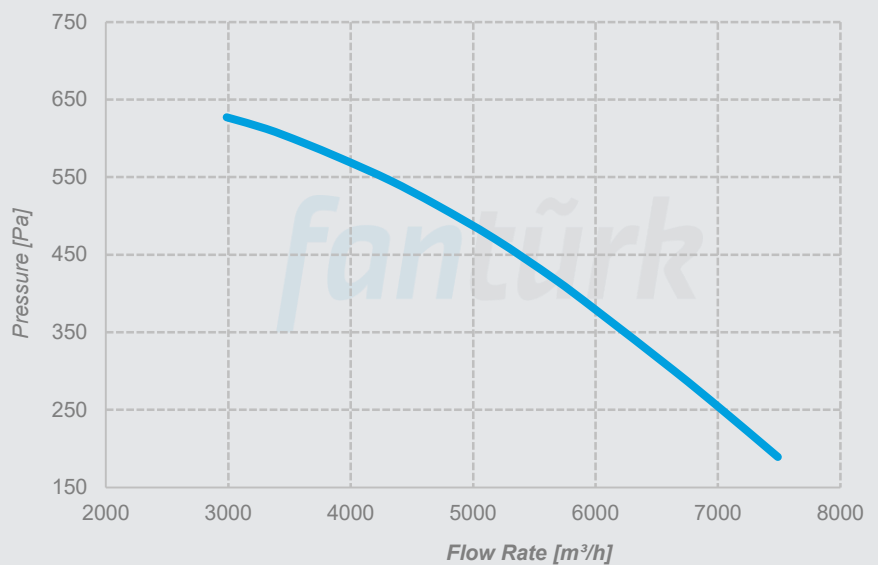

## Performance Curves

### ÇTF 355/2,2

Voltage 380 V  
Frequency 50 Hz  
Motor Power 2,2 kW  
Motor Speed 1420 rpm  
Sound Pressure Level 69 dBA  
Weight 80 kg

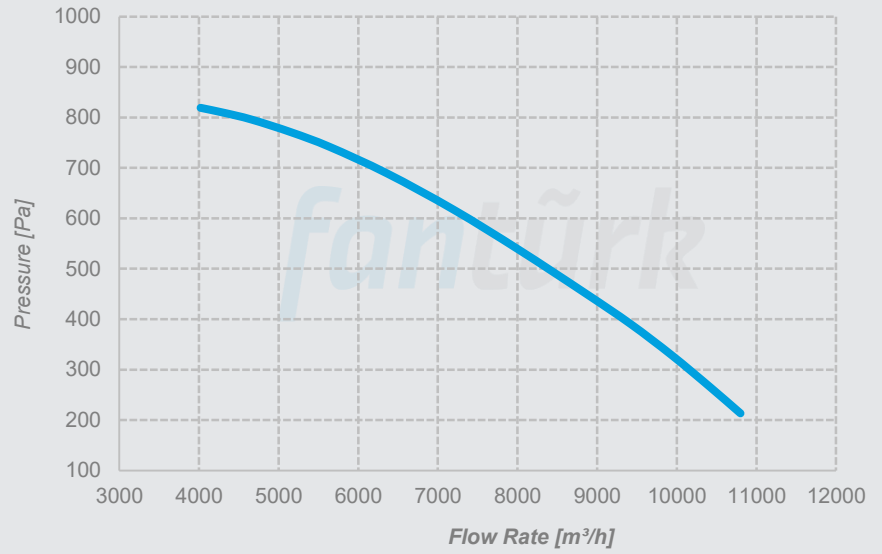

### ÇTF 400/1,1

Voltage 380 V  
Frequency 50 Hz  
Motor Power 1,1 kW  
Motor Speed 930 rpm  
Sound Pressure Level 60 dBA  
Weight 85 kg

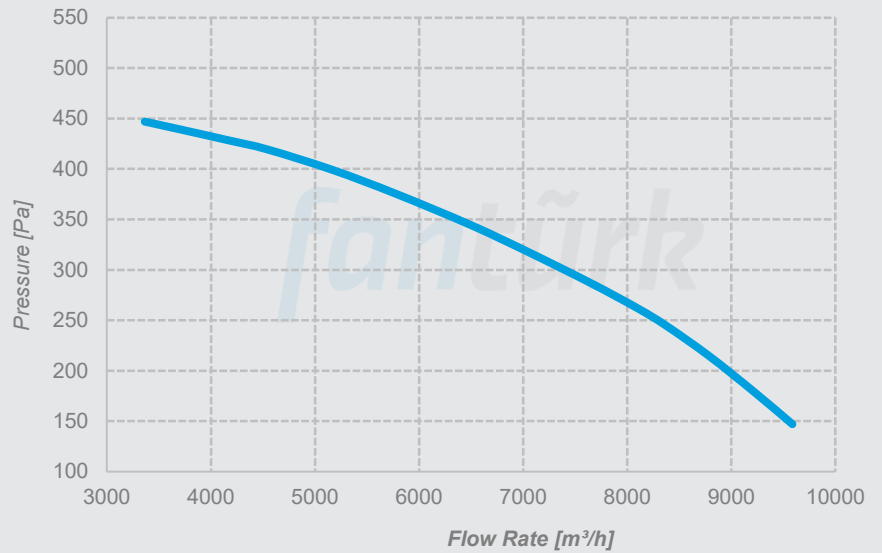

### ÇTF 400/4

Voltage 380 V  
Frequency 50 Hz  
Motor Power 4 kW  
Motor Speed 1430 rpm  
Sound Pressure Level 70 dBA  
Weight 105 kg

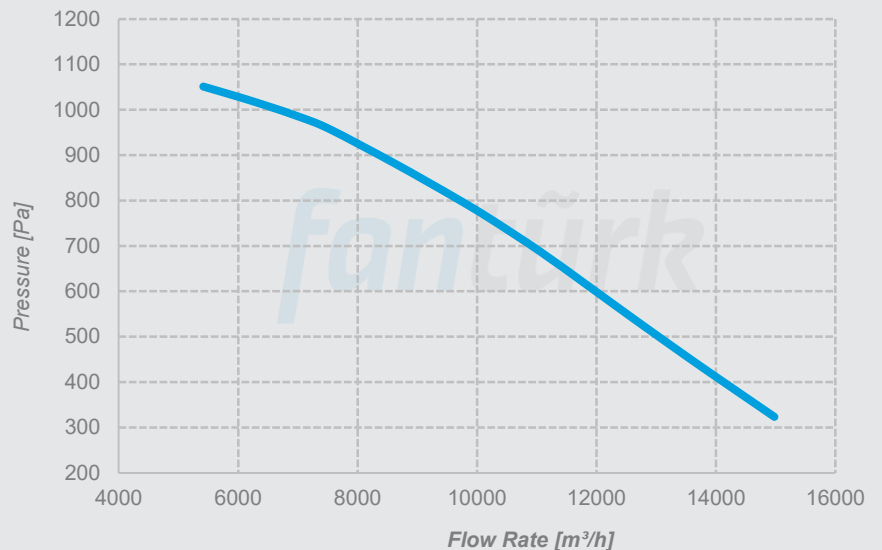

## Performance Curves

### ÇTF 450/2,2

Voltage 380 V  
Frequency 50 Hz  
Motor Power 2,2 kW  
Motor Speed 950 rpm  
Sound Pressure Level 68 dBA  
Weight 130 kg

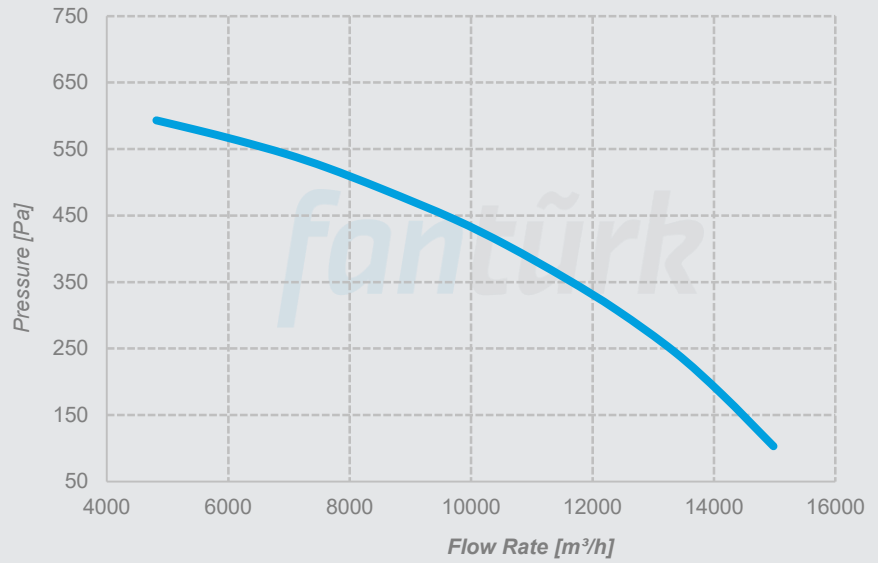

### ÇTF 450/5,5

Voltage 380 V  
Frequency 50 Hz  
Motor Power 5,5 kW  
Motor Speed 1440 rpm  
Sound Pressure Level 63 dBA  
Weight 130 kg

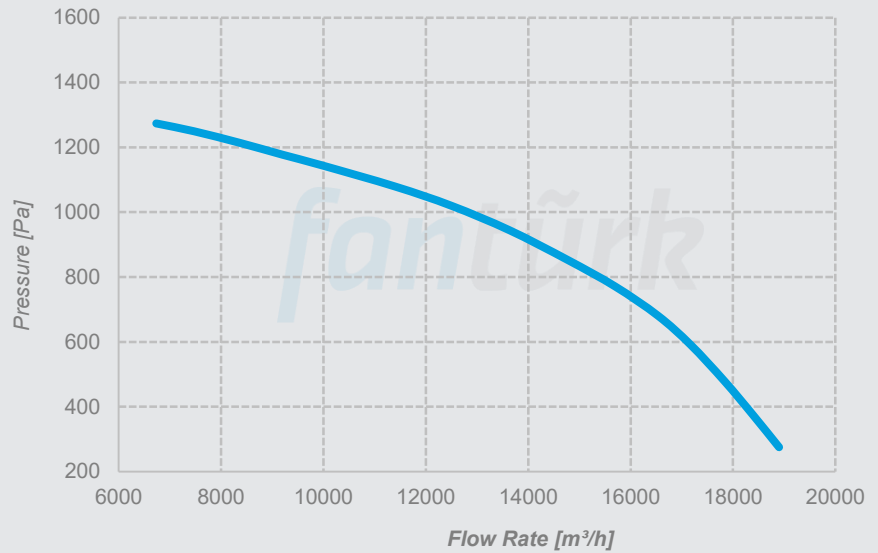

### ÇTF 450/7,5

Voltage 380 V  
Frequency 50 Hz  
Motor Power 7,5 kW  
Motor Speed 1450 rpm  
Sound Pressure Level 72 dBA  
Weight 151 kg

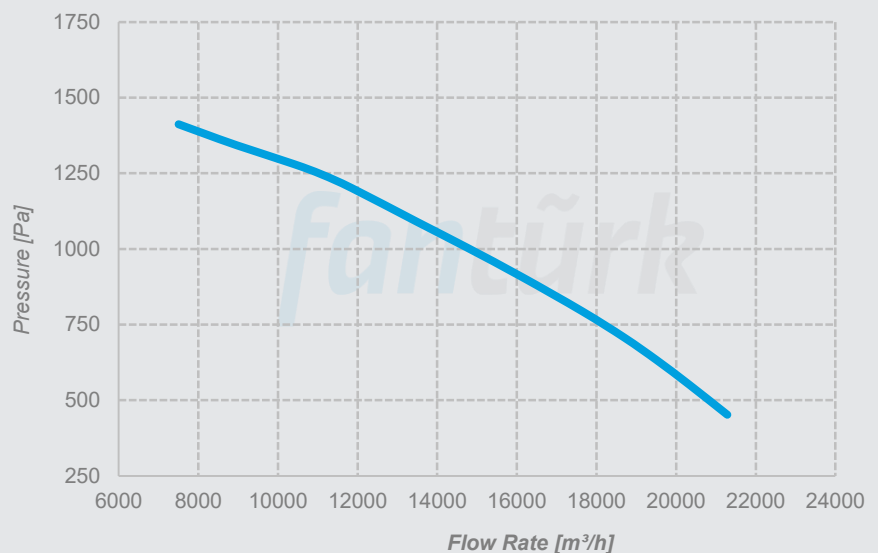

*Minarelicavus OSB District 202. Street No: 19 Nilüfer/Bursa Turkey  
T: 90(224)482 50 95 E: info@fanturk.com.tr*

*fanturk.com.tr*