

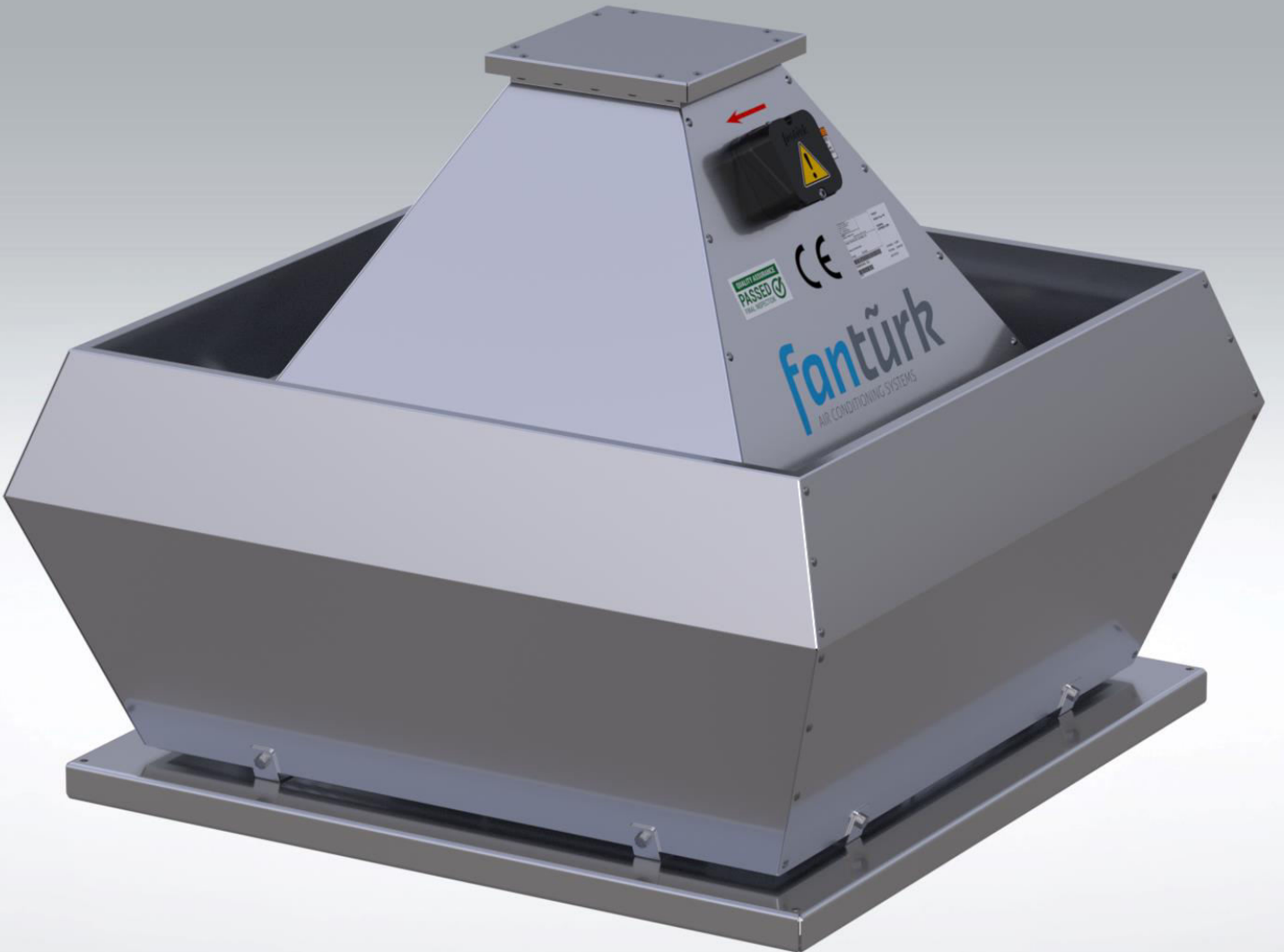

Product Catalogue



ÇTF
External Driven
Roof Type Vertical
Flow Radial Fan



Technical Specifications

EXTERNAL DRIVEN ROOF TYPE VERTICAL FLOW RADIAL FAN

ÇTF (380V) series roof type radial fans; are the ideal fans for roof installation in ventilation systems where high air flow and high pressure are required. Airflow is provided in the vertical direction thanks to a part mounted on the body.

Made of high quality corrosion resistant galvanized steel. Fans are radial fans with backward curved blades. Motors are three-phase and have 4 pole, IP55 and Class F insulation. Due to the fact that the motor is out of the air flow, it is protected from the factors that will damage the motor or hot air. This method provides 120 ° C continuous operation. Frequency controller is optional for all models.

Usage Areas

Can be used in ventilation systems where the exhaust air is likely to damage the motor, in oily exhaust air from kitchens, and all kinds of industrial buildings, office and residential buildings.

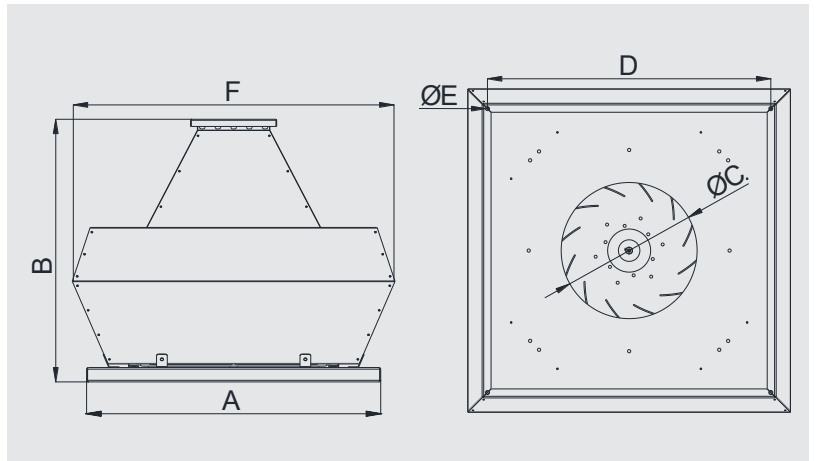
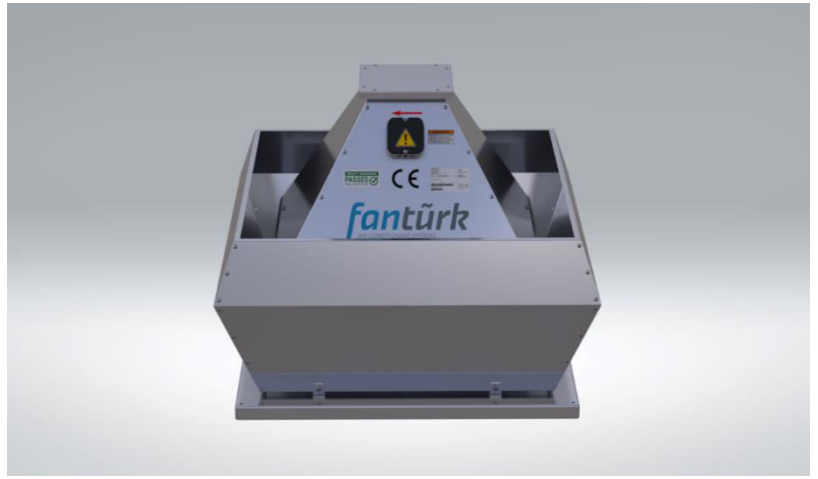

MODEL	A	B	C	D	E	F	VOLTAGE	FREQUENCY	MOTOR POWER	CURRENT	MOTOR SPEED	FLOW RATE	PRESSURE	SOUND PRESSURE LEVEL	WEIGHT
	mm	mm	mm	mm	mm	mm	V	Hz	kW	A	rpm	m ³ /h	Pa	dB(A)	kg
ÇTF 250/0.37	620	583	257	590	9	800	380	50	0,37	1,2	1360	3000	250	62	65
ÇTF 280/0.55	680	603	260	640	9	800	380	50	0,55	1,6	1370	4500	250	64	70
ÇTF 315/1.1	720	642	291	690	9	850	380	50	1,1	2,6	1390	6000	250	67	81
ÇTF 355/2.2	820	751	379	790	9	900	380	50	2,2	5,2	1420	9000	250	69	92
ÇTF 400/1.1	870	761	395	840	9	950	380	50	1,1	2,9	930	9000	250	60	99
ÇTF 400/4	870	761	395	840	9	950	380	50	4	8,2	1430	12000	250	70	119
ÇTF 450/2.2	950	936	430	920	9	1150	380	50	2,2	5,4	950	12000	250	63	151
ÇTF 450/5.5	950	936	430	920	9	1150	380	50	5,5	11,2	1440	15000	250	71	159
ÇTF 450/7.5	950	936	430	920	9	1150	380	50	7,5	15,4	1450	18000	250	72	172

Performance Curves

ÇTF 250/0,37

Voltage 380 V
Frequency 50 Hz
Motor Power 0,25 kW
Motor Speed 1360 rpm
Sound Pressure Level 62 dBA
Weight 55 kg

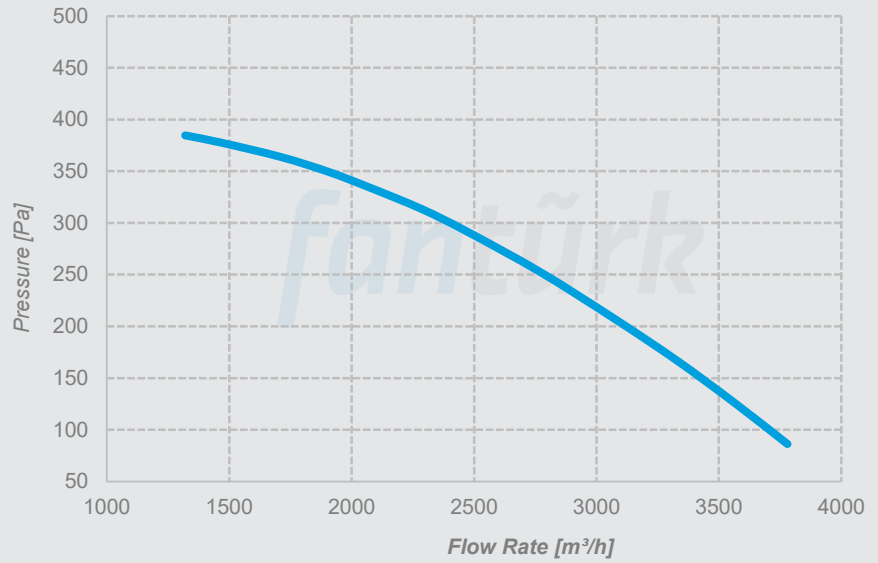

ÇTF 280/0,55

Voltage 380 V
Frequency 50 Hz
Motor Power 0,55 kW
Motor Speed 1370 rpm
Sound Pressure Level 64 dBA
Weight 60 kg

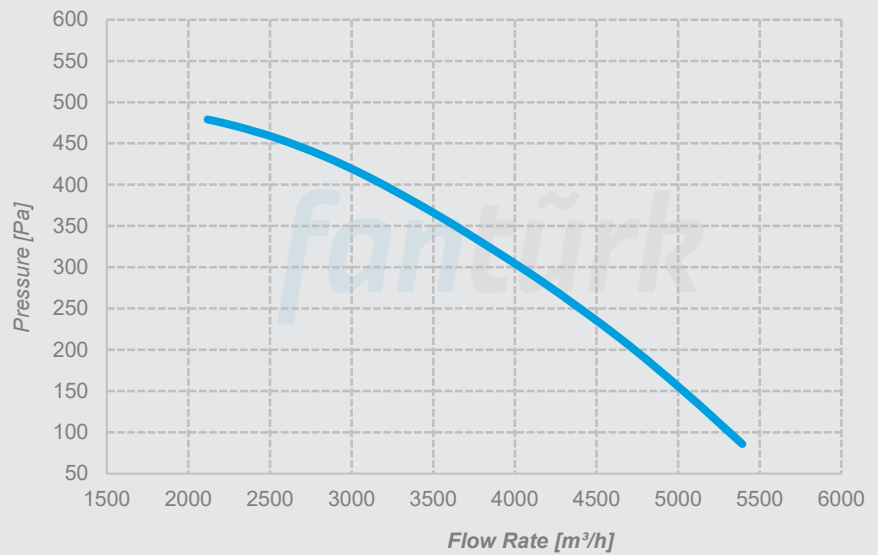

ÇTF 315/1,1

Voltage 380 V
Frequency 50 Hz
Motor Power 1,1 kW
Motor Speed 1390 rpm
Sound Pressure Level 67 dBA
Weight 70 kg

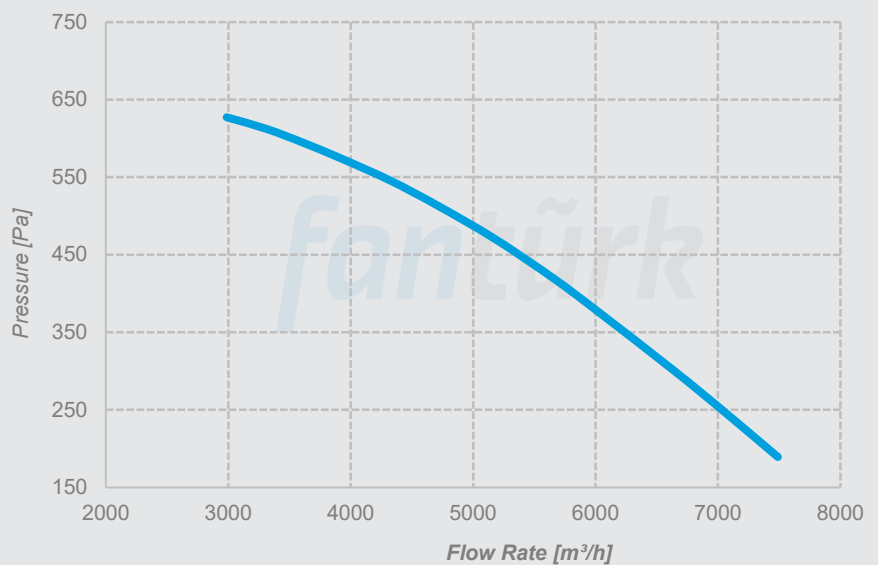

Performance Curves

ÇTF 355/2,2

Voltage 380 V
Frequency 50 Hz
Motor Power 2,2 kW
Motor Speed 1420 rpm
Sound Pressure Level 69 dBA
Weight 80 kg

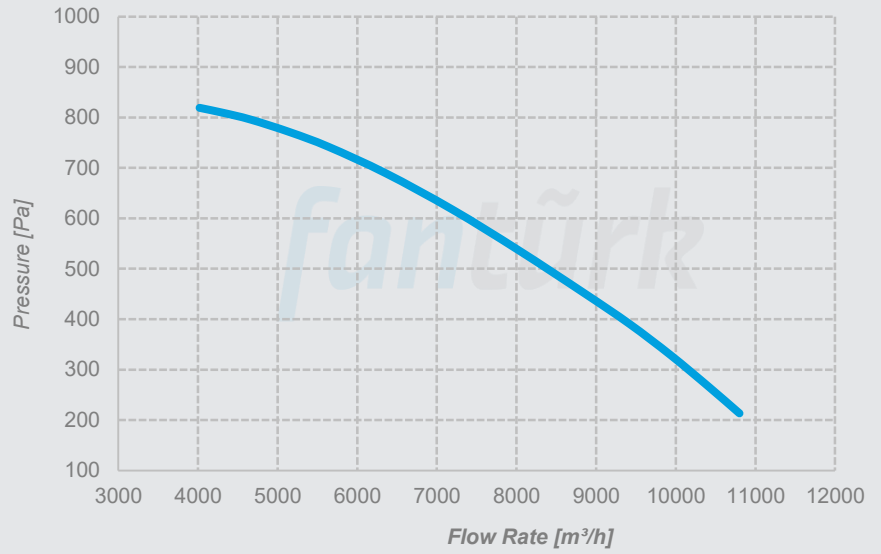

ÇTF 400/1,1

Voltage 380 V
Frequency 50 Hz
Motor Power 1,1 kW
Motor Speed 930 rpm
Sound Pressure Level 60 dBA
Weight 85 kg

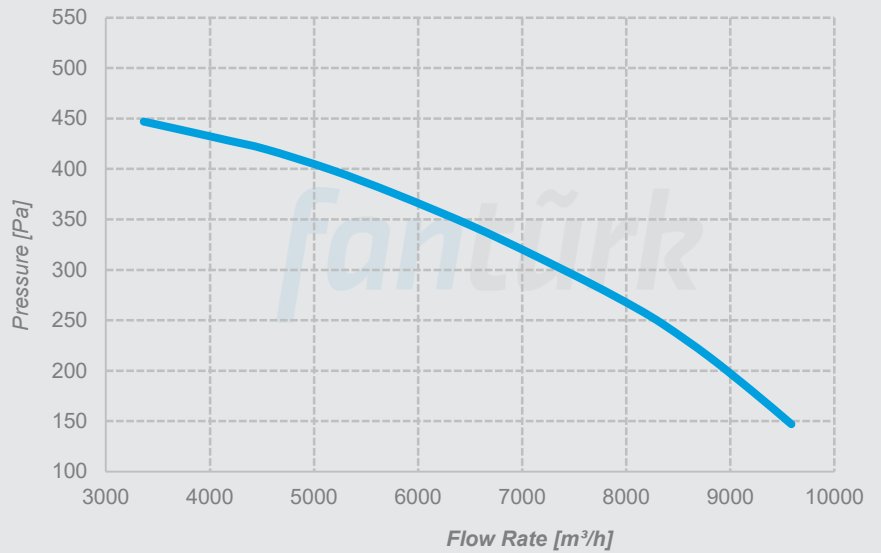

ÇTF 400/4

Voltage 380 V
Frequency 50 Hz
Motor Power 4 kW
Motor Speed 1430 rpm
Sound Pressure Level 70 dBA
Weight 105 kg

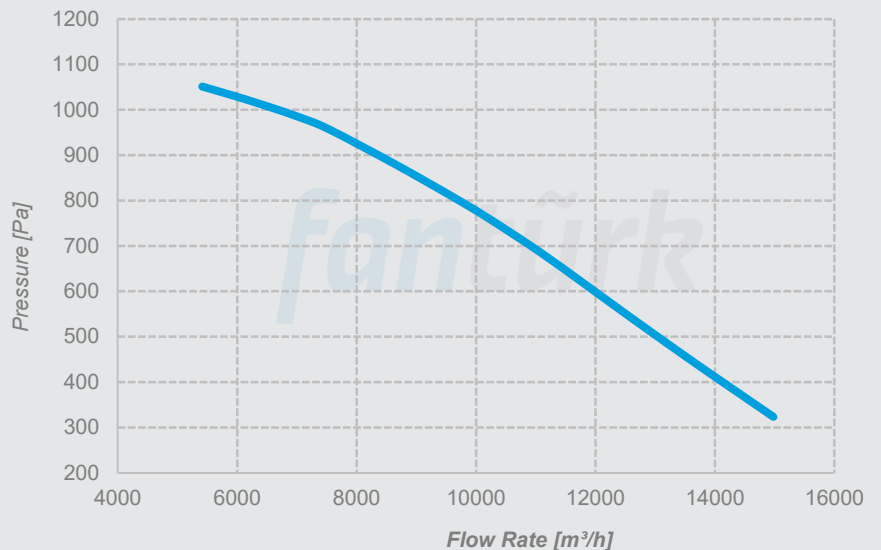

Performance Curves

ÇTF 450/2,2

Voltage 380 V
Frequency 50 Hz
Motor Power 2,2 kW
Motor Speed 950 rpm
Sound Pressure Level 68 dBA
Weight 130 kg

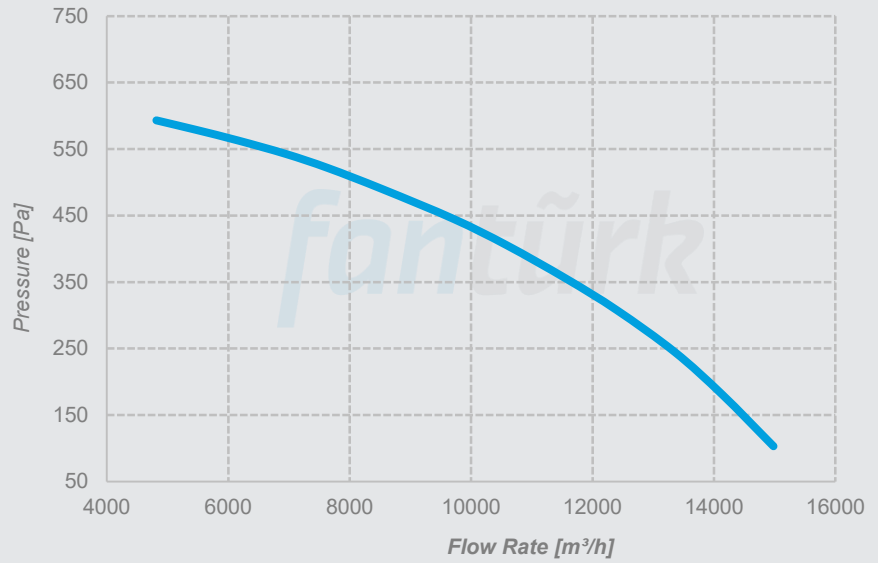

ÇTF 450/5,5

Voltage 380 V
Frequency 50 Hz
Motor Power 5,5 kW
Motor Speed 1440 rpm
Sound Pressure Level 63 dBA
Weight 130 kg

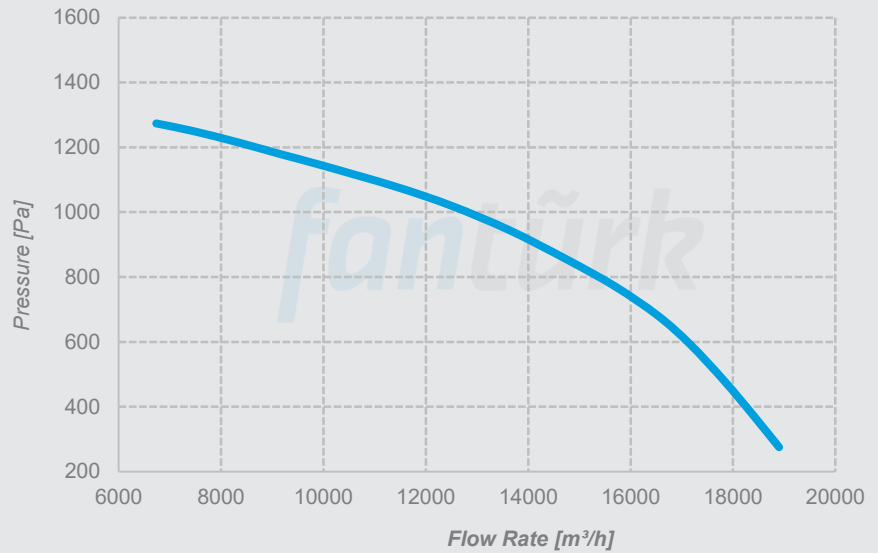

ÇTF 450/7,5

Voltage 380 V
Frequency 50 Hz
Motor Power 7,5 kW
Motor Speed 1450 rpm
Sound Pressure Level 72 dBA
Weight 151 kg

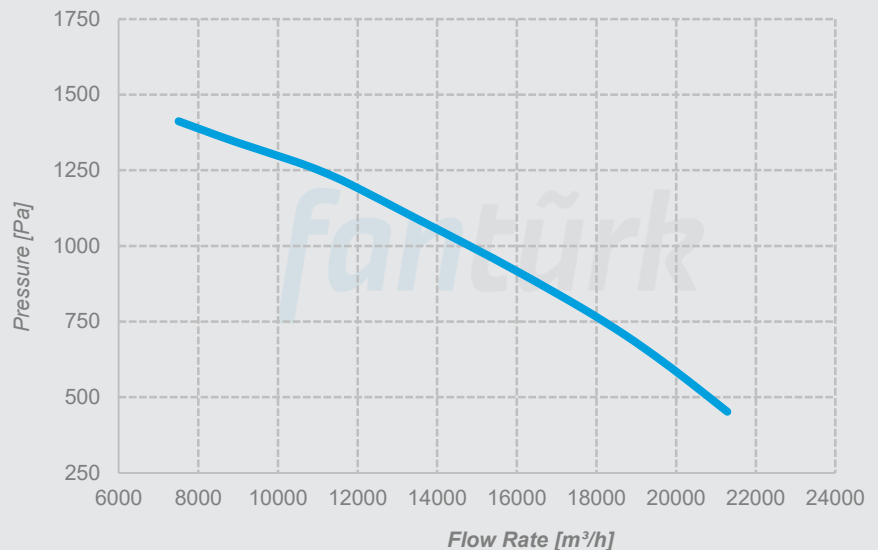

*Minarelicavus OSB District 202. Street No: 19 Nilüfer/Bursa Turkey
T: 90(224)482 50 95 E: info@fanturk.com.tr*

fanturk.com.tr