



# ***Product Catalogue***



# *SHS Duct Type Shelter Ventilation Unit*



## Shelter Ventilation Regulation

Regardless of the type of shelter, mechanical ventilation is mandatory. During protection times the in-take air to the shelter passes three step filtration which are G4 Filter, Activated Carbon Filter and Nuclear Hepa Filter. In peacetime, the in-take air only passes through G4 filter and fed into the shelter. Air flow rate required for one person during protection times is mentioned in the table below. The following capacity values are minimum values and any additional measures to improve air quality can be used in the design.

Duct design, layout and number of vents are arranged by the mechanical installation project designer. This arrangement has to be made in accordance with TS 3419 "Ventilation and Air Conditioning Facilities-Design Rules" and TS 3420 "Ventilation and Air Conditioning Facilities Installation Rules" standards.

<b>SHELTER CAPACITY</b>	<b>REQUIRED AIR FLOW (Protection Times)</b>	<b>HIGH FIRE HAZARD</b>	<b>LOW AND MEDIUM FIRE HAZARD</b>
Up to 0-50 people	1.8 m <sup>3</sup> /h-person	Sand filter, G4 dust filter, activated carbon filter	G4 dust filter, radioactive filter and activated carbon filter
Between 51-150 people	3 m <sup>3</sup> /h-person	Sand filter, G4 dust filter, activated carbon filter	G4 dust filter, radioactive filter and activated carbon filter
More than 150 people	4.5 m <sup>3</sup> /h-person	Sand filter, G4 dust filter, activated carbon filter	G4 dust filter, radioactive filter and activated carbon filter

3194 - Zoning Law - Shelter Regulation Principles - Ventilation Calculation Table

### Sample Calculation;

**Total Construction Area:  $A = 3000 \text{ m}^2$**

**Number of people in the shelter:  $N = A / 2 = 3000/20 = 150$**

**Normal and protected air flow requirement per person:  $Q = 3 \text{ m}^3 / \text{h-person}$**

**Total air flow requirement:  $V = Q \times N, V = 150 \text{ people} \times 3 \text{ m}^3 / \text{h-person} = 450 \text{ m}^3 / \text{h}$**

### General Features;

- Radioactive Nuclear Filter
- Activated Carbon Filter
- G4 Filter
- Backward Curved Plug Radial Fan
- High Efficiency & Low Noise
- By-Pass Damper
- Duct Type
- Ergonomic Mounting
- In accordance with the Manufacturing Regulation

### Optional Features;

- Lead Coating
- Lead Separator

### PLUG FAN

- Backward Curved Blades
- High efficiency
- Low power consumption
- Low noise level
- High static pressure
- Thermo protection element against overheating of the motor
- Easy to remove and service thanks to the service cover.



### NUCLEAR HEPA FILTER

**Media:** High quality glass fiber H13 (EN1822)

**Frame Materials:** Galvanized  
**Flammability Class:** K2 / F2 (K1 / F1 available)

**Max. Continuous Operating Temperature:** 120°C

**Design:** V-Module

**Gasket:** Silicone

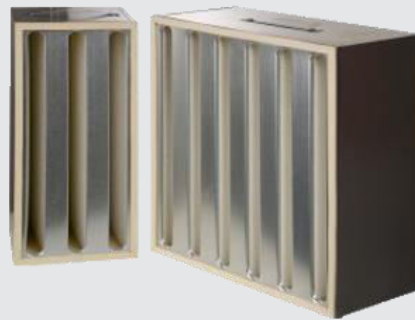

### G4 FILTER

**Media:** High quality glass fiber H13 (EN1822)

**Frame Materials:** Galvanized  
**Flammability Class:** K2 / F2 (K1 / F1 available)

**Max. Continuous Operating Temperature:** 120°C

**Design:** V-Module

**Gasket:** Silicone

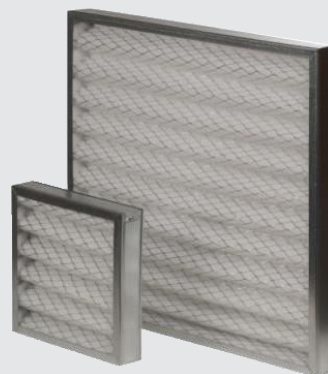

### ACTIVATED CARBON FILTER

**Media:** Active carbon impregnated synthetic fiber

**Media Weight:** 400 g

**Frame Type:** Galvanized

**Max. Continuous Operating Temperature:** 75°C

**Flammability Class:** K2 / F2 at normal temperature

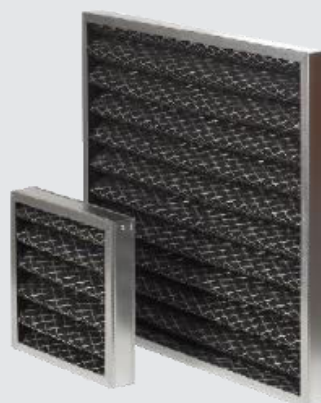

## Technical Specifications

# DUCT TYPE SHELTER VENTILATION UNIT WITH FILTERS

SHS series shelter ventilation units are the most ideal devices for shelter ventilation systems. Thanks to their compact construction, they can be installed directly in air ducts, without the need for large bends and transducers.

The body is made of high quality corrosion-resistant galvanized steel. The fans are radial fans with backward curved blades. Thanks to the service cover, the fan and filters can be carry out maintenance without removing the duct connection. Depending on the project, lead coating or lead separator may be added.

### Usage Areas

Can be used in shelter ventilation systems for all kinds of offices, residences, hospitals and residential buildings.

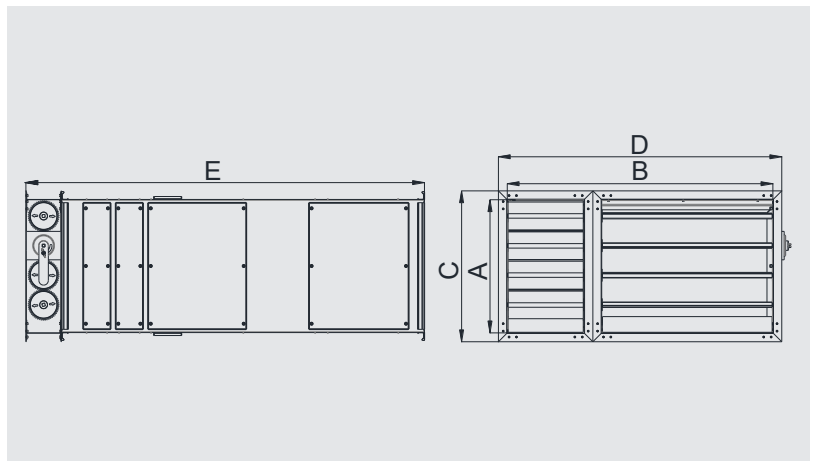

MODEL	A	B	C	D	E	FLOW RATE	VOLTAGE	FREQUENCY	MOTOR POWER	CURRENT	CAPACITOR	MOTOR SPEED	SOUND PRESSURE LEVEL	WEIGHT
	mm	mm	mm	mm	mm	m <sup>3</sup> /h	V	Hz	W	A	µF	rpm	dBa	kg
SHS-1	300	400	370	460	1250	600	230	50	100	0,47	3	2580	53	25
SHS-2	350	500	410	560	1250	850	230	50	150	0,65	4	2680	55	30
SHS-3	350	500	410	560	1250	1150	230	50	200	0,9	6	2650	56	30
SHS-4	350	900	410	960	1250	1500	230	50	250	1,1	8	2500	50	45
SHS-5	450	900	510	960	1350	1800	230	50	210	1	8	1400	53	66
SHS-6	650	900	710	960	1350	3000	230	50	500	1,8	12	1380	60	91
SHS-7	650	900	710	960	1350	3600	230	50	500	1,8	12	1380	60	91
SHS-8	650	900	710	960	1350	4350	230	50	800	3,7	16	1350	64	91
SHS-9	650	1300	710	1360	1520	7600	230	50	1550	6,8	31	1380	66	136

# Performance Curves

## SHS-1

Voltage 230 V  
Frequency 50 Hz  
Motor Power 100 W  
Current 0,47 A  
Capacitor 3  $\mu$ f  
Motor Speed 2580 rpm  
Flow Rate 600 m<sup>3</sup>/h  
Sound Pressure Level 53 dBA  
Weight 25 kg

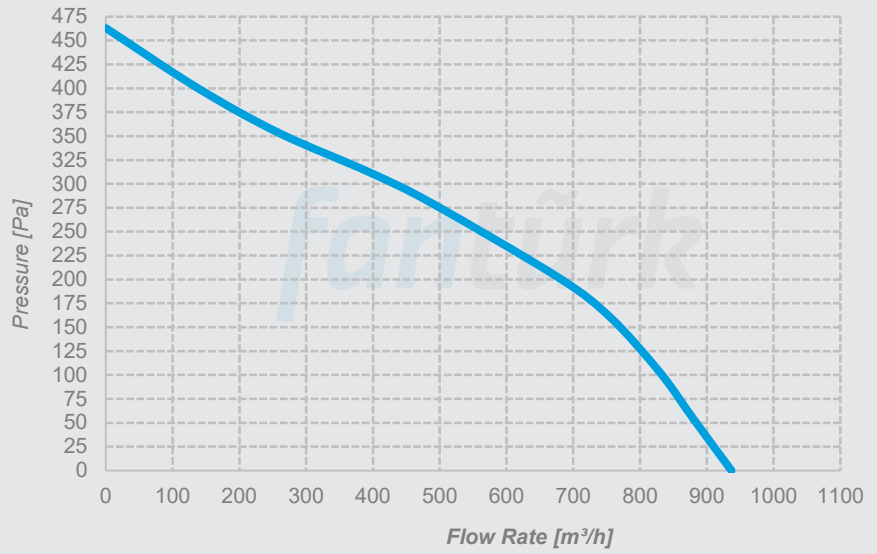

## SHS-2

Voltage 230 V  
Frequency 50 Hz  
Motor Power 150 W  
Current 0,65 A  
Capacitor 4  $\mu$ f  
Motor Speed 2680 rpm  
Flow Rate 850 m<sup>3</sup>/h  
Sound Pressure Level 55 dBA  
Weight 30 kg

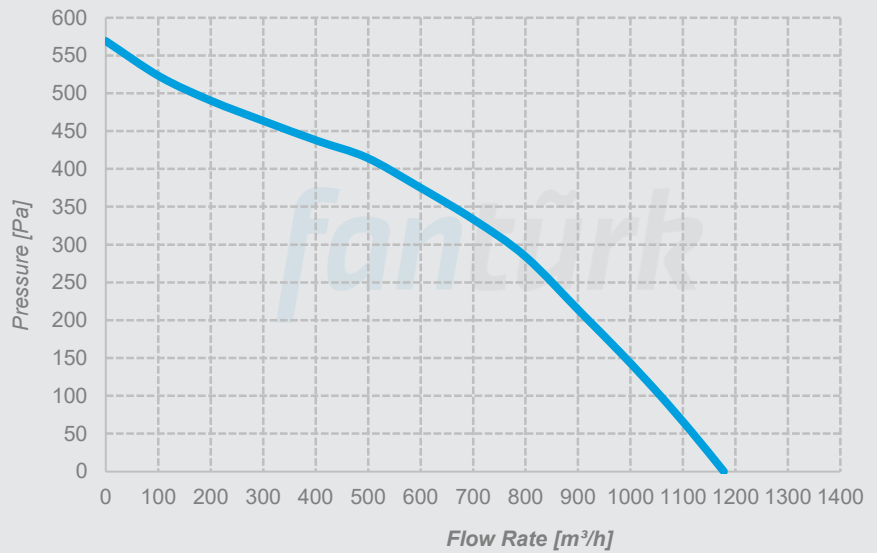

## SHS-3

Voltage 230 V  
Frequency 50 Hz  
Motor Power 200 W  
Current 0,9 A  
Capacitor 6  $\mu$ f  
Motor Speed 2650 rpm  
Flow Rate 1150 m<sup>3</sup>/h  
Sound Pressure Level 56 dBA  
Weight 30 kg

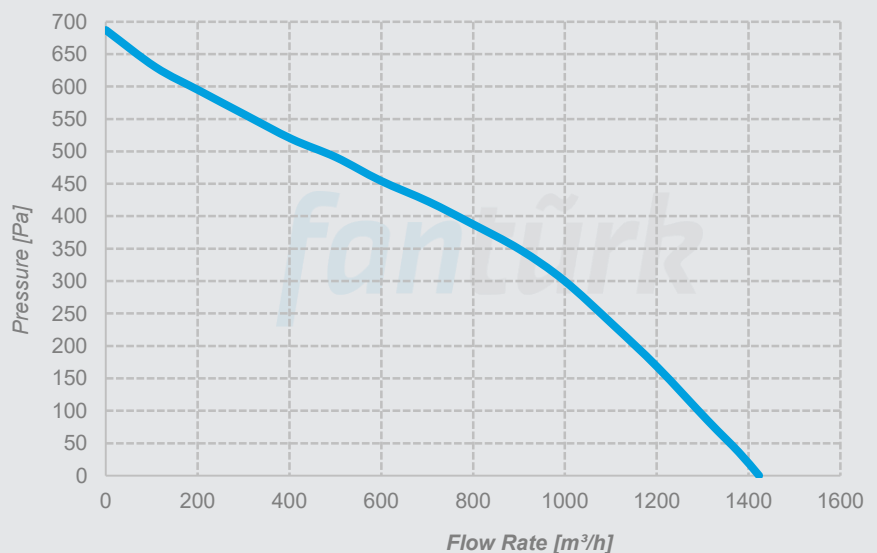

## Performance Curves

### SHS-4

Voltage 230 V  
Frequency 50 Hz  
Motor Power 250 W  
Current 1,1 A  
Capacitor 8  $\mu$ f  
Motor Speed 2500 rpm  
Flow Rate 1500 m<sup>3</sup>/h  
Sound Pressure Level 50 dBA  
Weight 45 kg

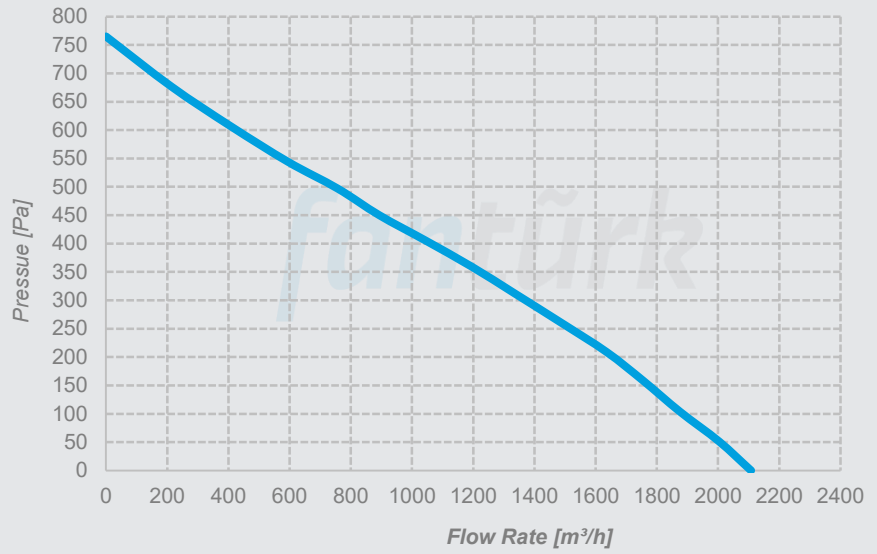

### SHS-5

Voltage 230 V  
Frequency 50 Hz  
Motor Power 210 W  
Current 1 A  
Capacitor 8  $\mu$ f  
Motor Speed 1400 rpm  
Flow Rate 1800 m<sup>3</sup>/h  
Sound Pressure Level 53 dBA  
Weight 66 kg

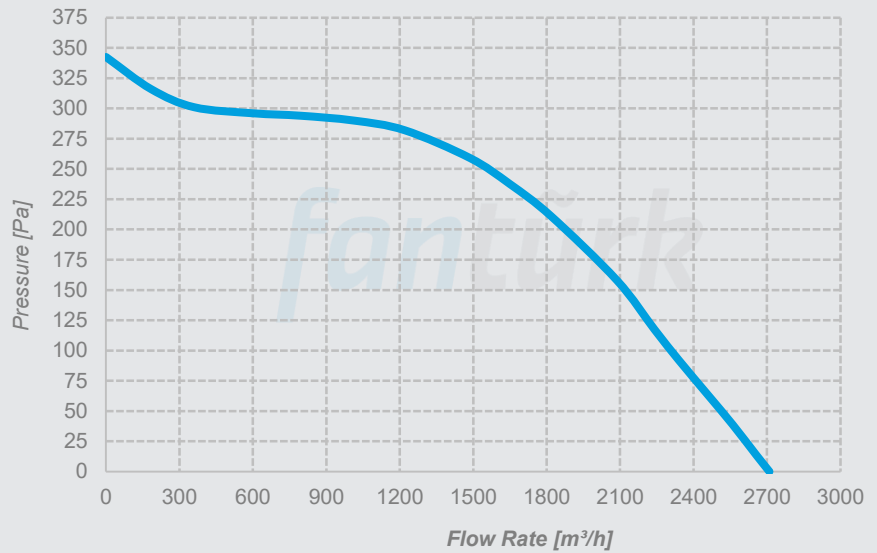

### SHS-6

Voltage 230 V  
Frequency 50 Hz  
Motor Power 500 W  
Current 1,8 A  
Capacitor 12  $\mu$ f  
Motor Speed 1380 rpm  
Flow Rate 3000 m<sup>3</sup>/h  
Sound Pressure Level 60 dBA  
Weight 91 kg

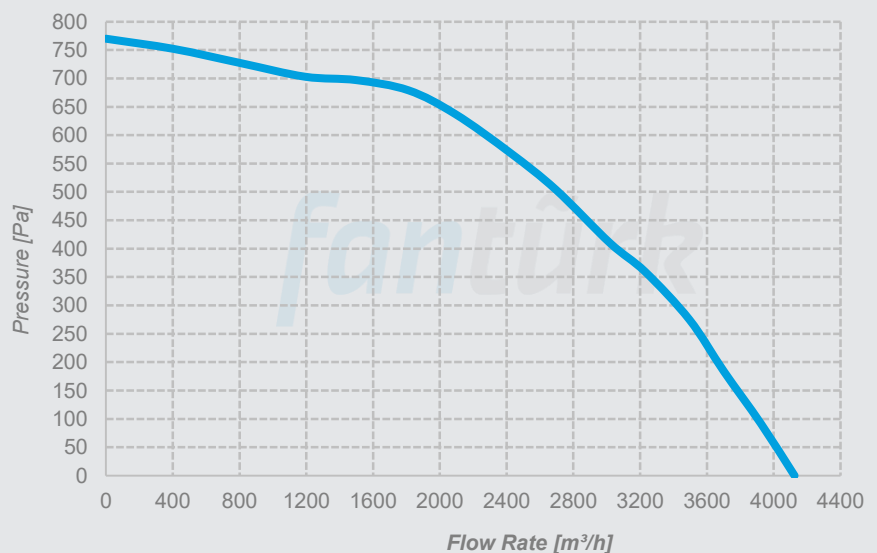

## Performance Curves

### SHS-7

Voltage 230 V  
Frequency 50 Hz  
Motor Power 500 W  
Current 1,8 A  
Capacitor 12  $\mu$ f  
Motor Speed 1380 rpm  
Flow Rate 3600 m<sup>3</sup>/h  
Sound Pressure Level 60 dBA  
Weight 91 kg

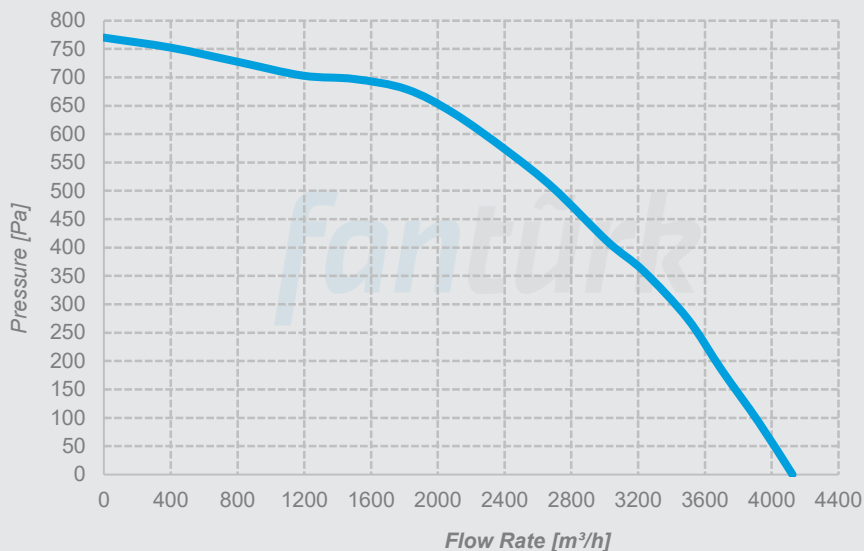

### SHS-8

Voltage 230 V  
Frequency 50 Hz  
Motor Power 800 W  
Current 3,7 A  
Capacitor 16  $\mu$ f  
Motor Speed 1350 rpm  
Flow Rate 4350 m<sup>3</sup>/h  
Sound Pressure Level 64 dBA  
Weight 91 kg

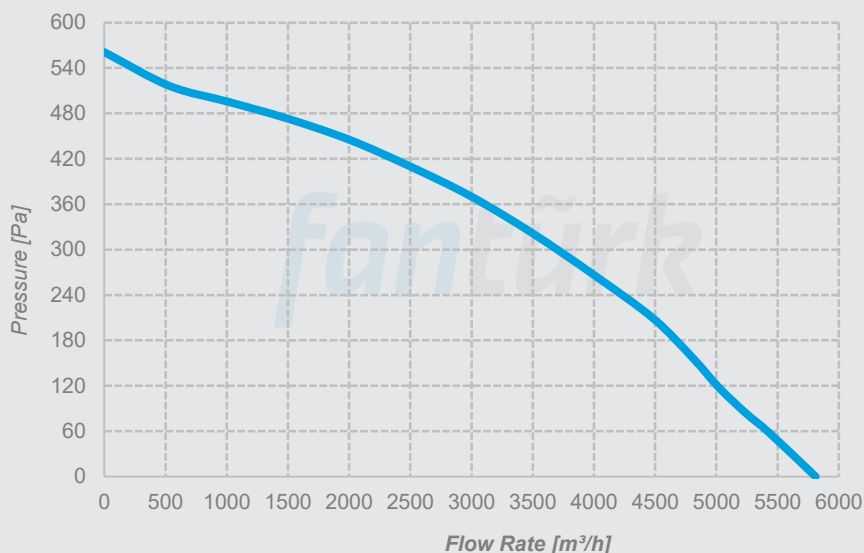

### SHS-9

Voltage 230 V  
Frequency 50 Hz  
Motor Power 1550 W  
Current 6,8 A  
Capacitor 31  $\mu$ f  
Motor Speed 1380 rpm  
Flow Rate 7600 m<sup>3</sup>/h  
Sound Pressure Level 66 dBA  
Weight 136 kg

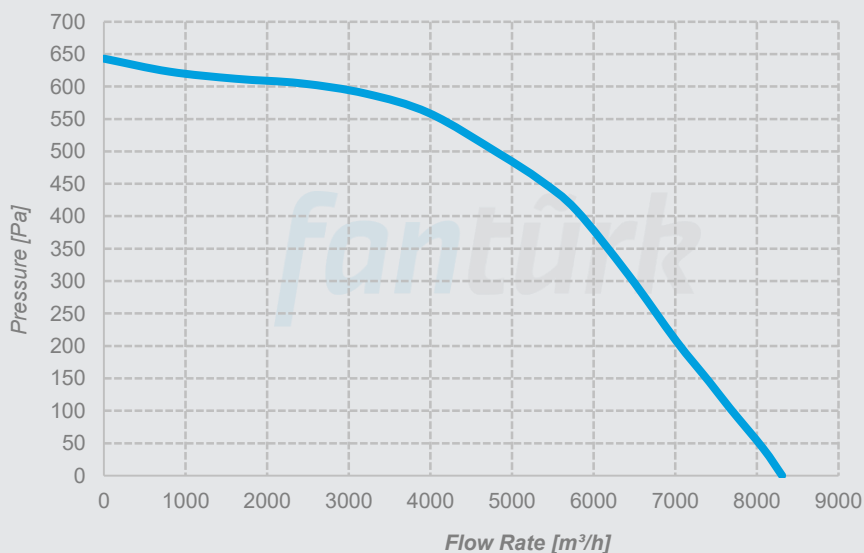



*Minarelicavus OSB District 202. Street No: 19 Nilüfer/Bursa Turkey  
T: 90(224)482 50 95 E: info@fanturk.com.tr*

*fanturk.com.tr*