

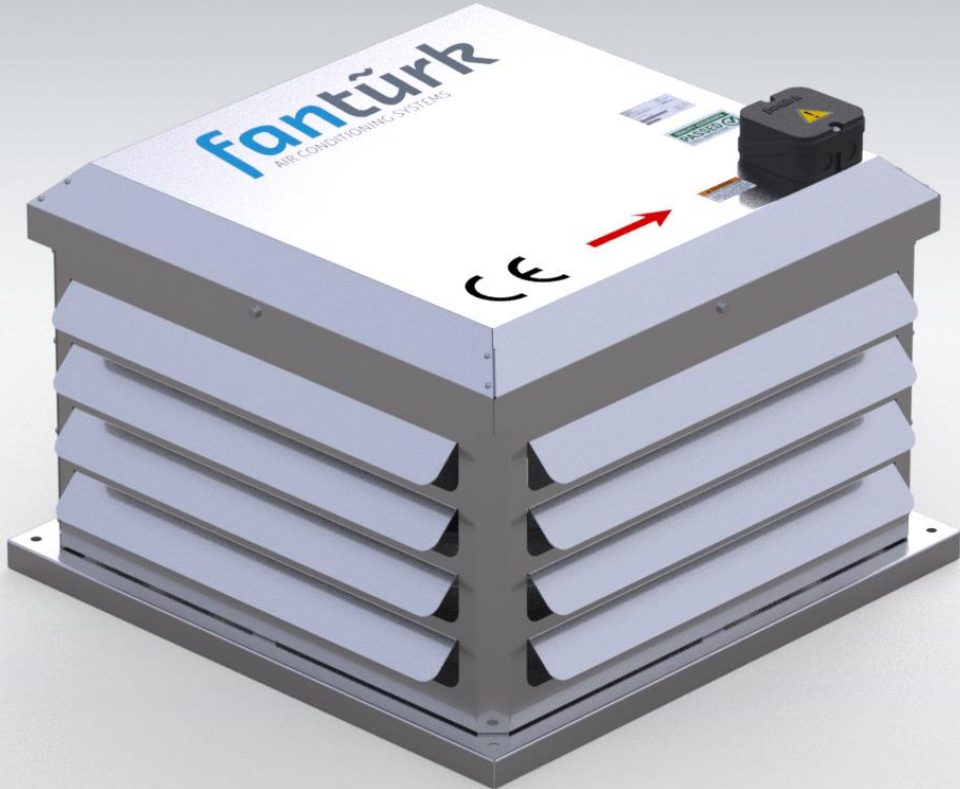

Product Catalogue



ÇTF Roof Type Radial Fan



Technical Specifications

ROOF TYPE RADIAL FAN

ÇTF (230V) series roof type radial fans; are the ideal fans for roof installation in ventilation systems where high air flow and high pressure are required. They have high performance and trouble-free operation specifications.

Made of high quality corrosion resistant galvanized steel. Fans are radial fans with backward curved blades. Motors are single phase and has IP55 and Class F insulation. Speed controller is optional for all models..

Usage Areas

Can be used in all kinds of industrial building, office, kitchen and residential building ventilation systems where compact solutions are needed.

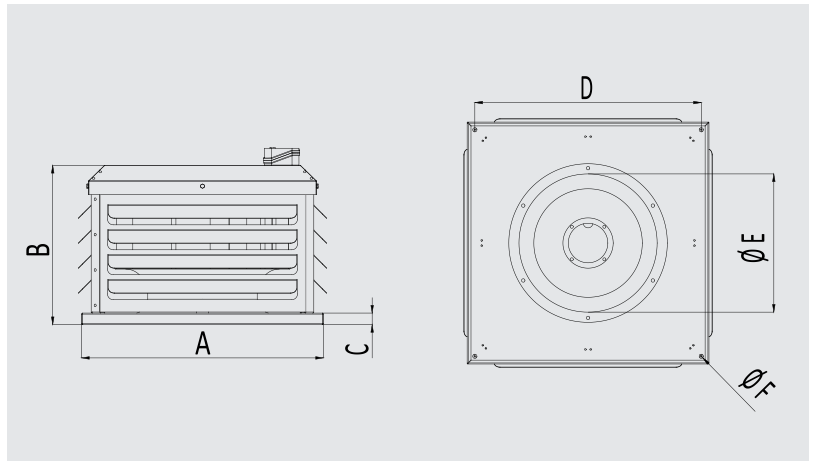
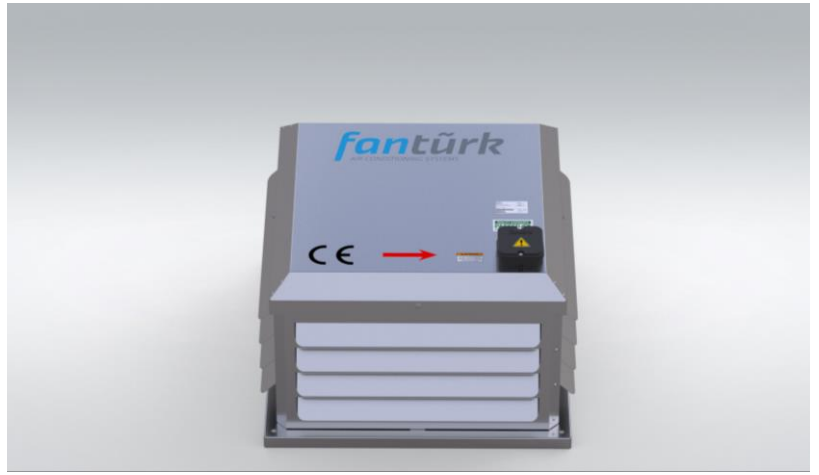

MODEL	A	B	C	D	E	F	VOLTAGE	FREQUENCY	POWER	CURRENT	CAPACITOR	MOTOR SPEED	AIR FLOW RATE	SOUND P. LEVEL	WEIGHT
	mm	mm	mm	mm	mm	mm	V	Hz	W	A	µf	rpm	m ³ /h	dBA	kg
ÇTF-1	320	171	30	280	145	9	230	50	76	0,29	1,5	2350	540	52	6,5
ÇTF-2	350	180	30	310	210	9	230	50	100	0,47	2,5	2580	925	56	8,3
ÇTF-3	360	210	30	320	195	9	230	50	160	0,68	3,5	2600	1150	63	8,5
ÇTF-4	380	220	30	340	220	9	230	50	180	0,8	5	2700	1520	58	9,7
ÇTF-5	410	250	30	370	250	9	230	50	285	1,5	7	2500	2110	76	11
ÇTF-6	500	300	30	460	270	9	230	50	272	1,23	12	1364	3150	72	17
ÇTF-7	570	352	30	530	320	11	230	50	500	1,8	9	1380	4400	61	28
ÇTF-8	630	400	30	590	390	11	230	50	800	3,7	14	1359	6000	62	31

Performance Curves

ÇTF-1

Voltage 230 V
Frequency 50 Hz
Current 76 W
Current 0,29 A
Capacitor 2,5 μ f
Motor Speed 2350 rpm
Flow Rate 540 m³/h
Sound Pressure Level 52 dBA
Weight 6,5 kg

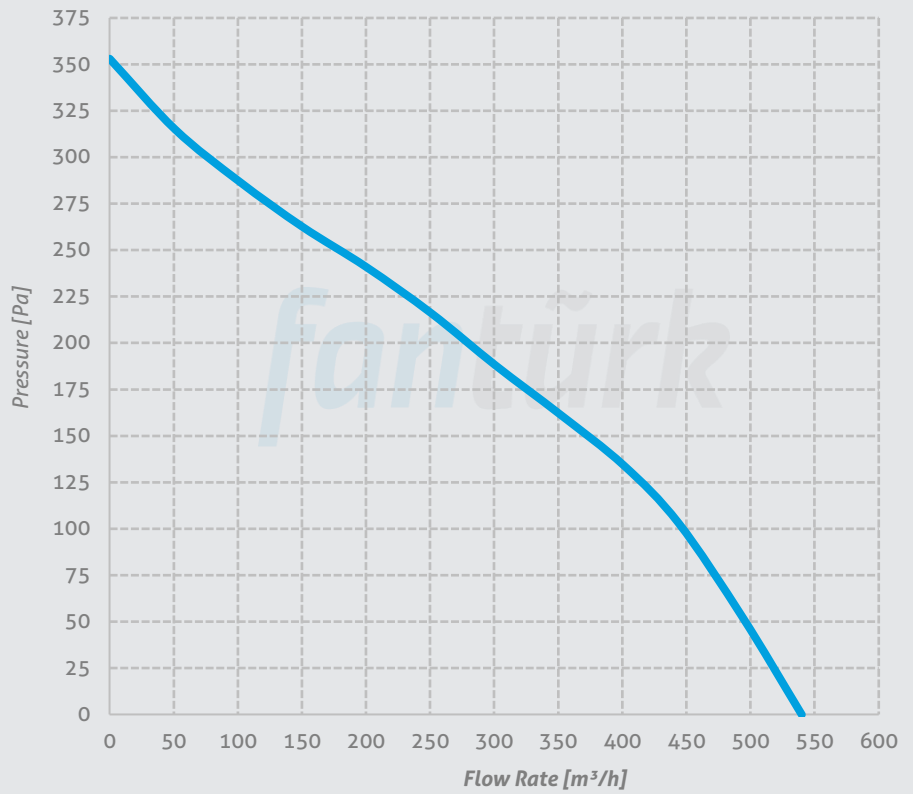

ÇTF-2

Voltage 230 V
Frequency 50 Hz
Current 100 W
Current 0,47 A
Capacitor 3 μ f
Motor Speed 2580 rpm
Flow Rate 925 m³/h
Sound Pressure Level 56 dBA
Weight 8,3 kg

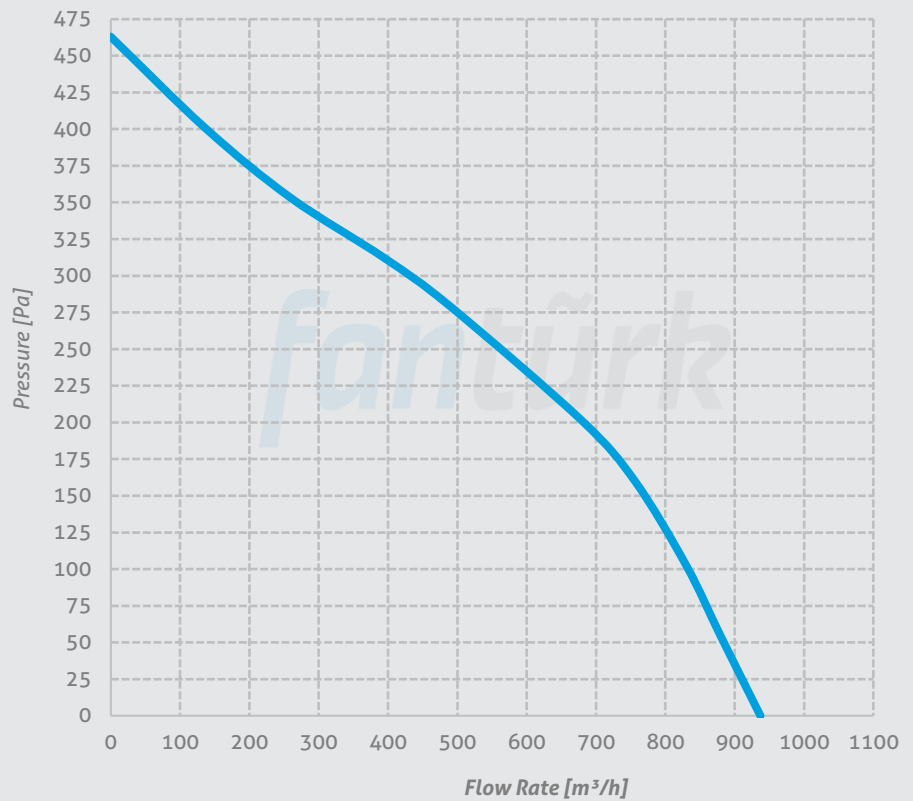

Performance Curves

ÇTF-3

Voltage 230 V
Frequency 50 Hz
Current 160 W
Current 0,68 A
Capacitor 4 μ f
Motor Speed 2600 rpm
Flow Rate 1150 m³/h
Sound Pressure Level 63 dBA
Weight 8,5 kg

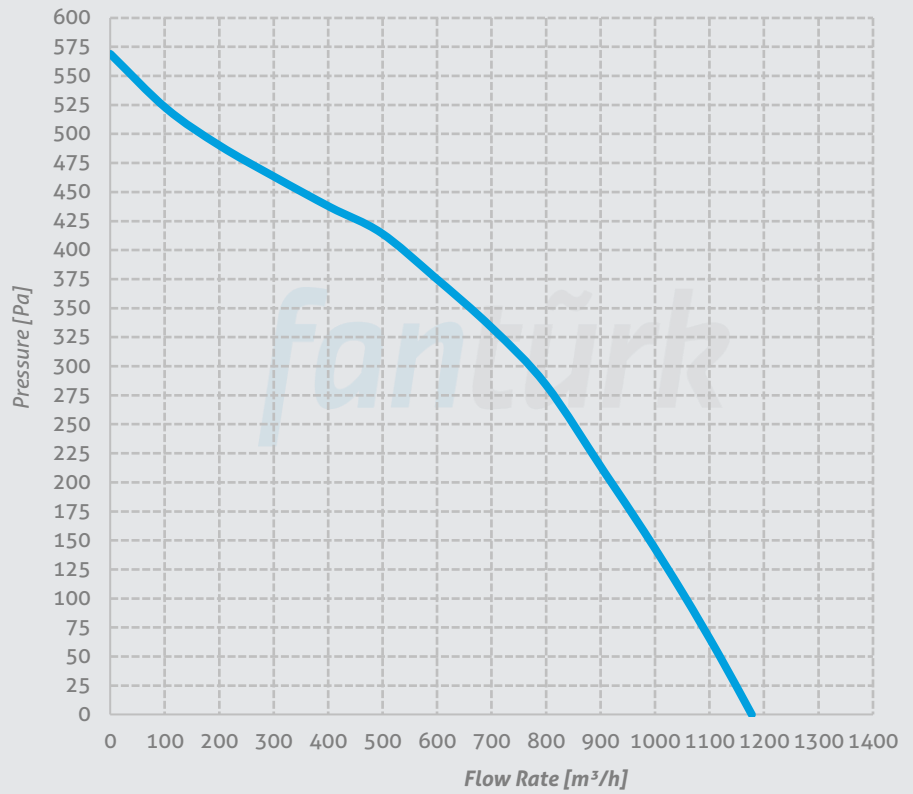

ÇTF-4

Voltage 230 V
Frequency 50 Hz
Current 180 W
Current 0,8 A
Capacitor 4 μ f
Motor Speed 2700 rpm
Flow Rate 1520 m³/h
Sound Pressure Level 58 dBA
Weight 9,7 kg

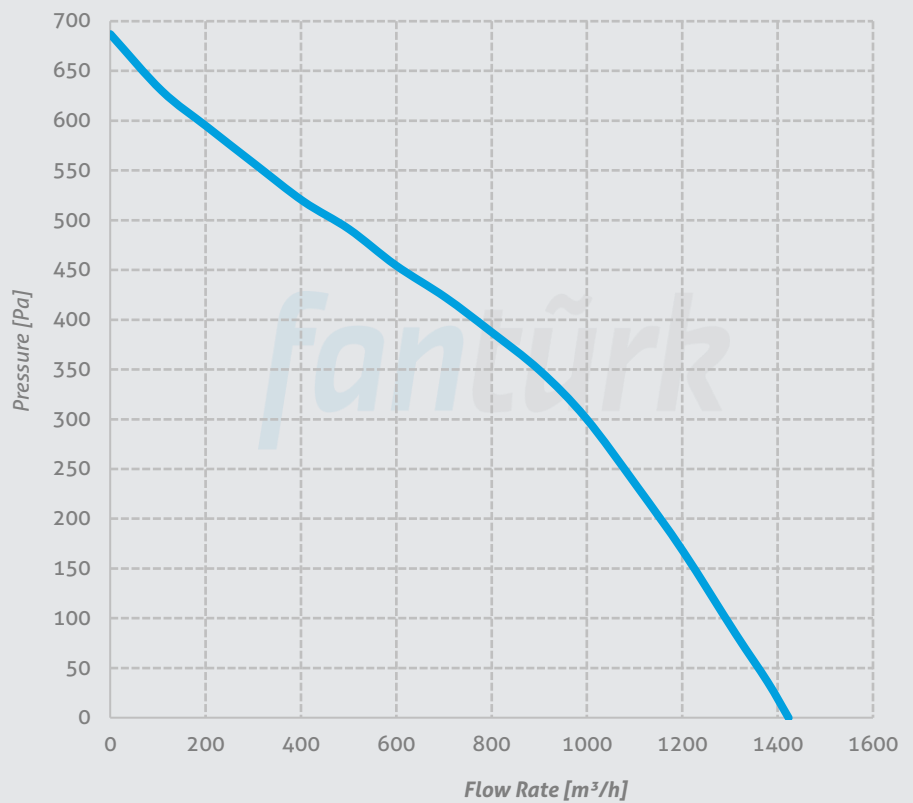

Performance Curves

ÇTF-5

Voltage 230 V
Frequency 50 Hz
Current 285 W
Current 1,5 A
Capacitor 5 μ f
Motor Speed 2500 rpm
Flow Rate 2110 m³/h
Sound Pressure Level 76 dBA
Weight 11 kg

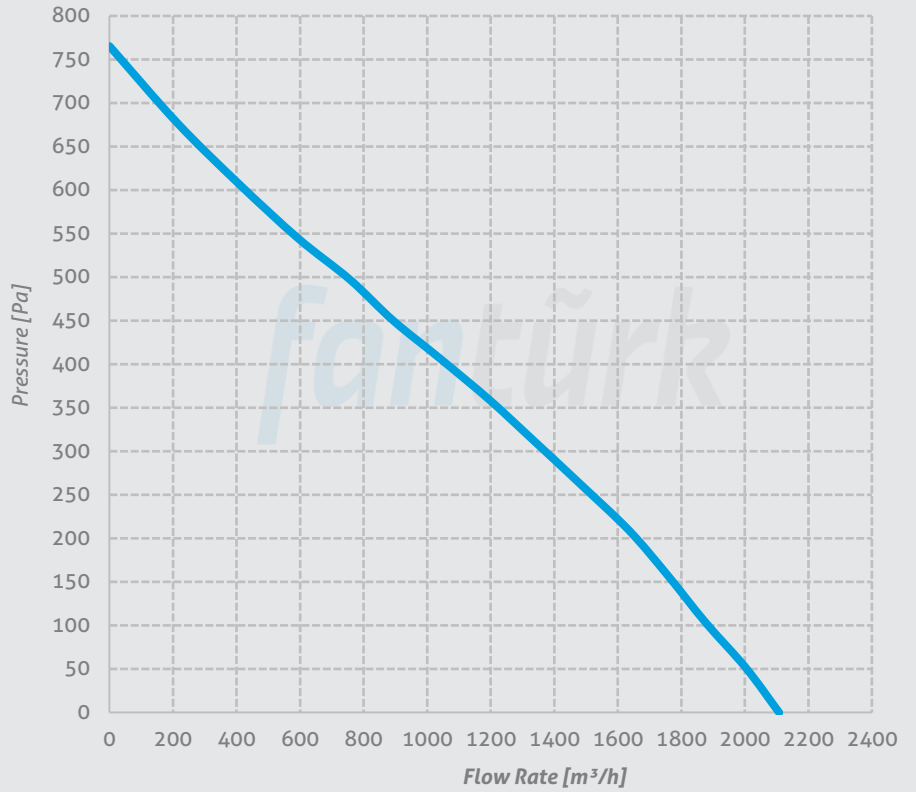

ÇTF-6

Voltage 230 V
Frequency 50 Hz
Current 272 W
Current 1,23 A
Capacitor 8 μ f
Motor Speed 1364 rpm
Flow Rate 3150 m³/h
Sound Pressure Level 72 dBA
Weight 17 kg

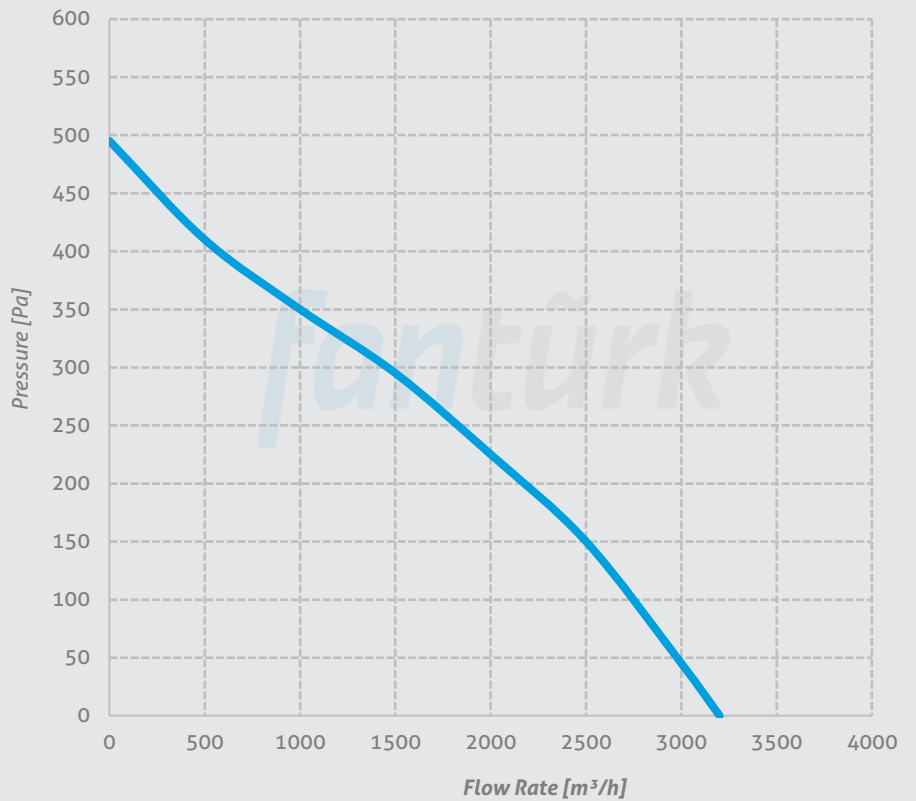

Performance Curves

ÇTF-7

Voltage 230 V
Frequency 50 Hz
Current 500 W
Current 1,8 A
Capacitor 12 μ f
Motor Speed 1380 rpm
Flow Rate 4400 m³/h
Sound Pressure Level 61 dBA
Weight 28 kg

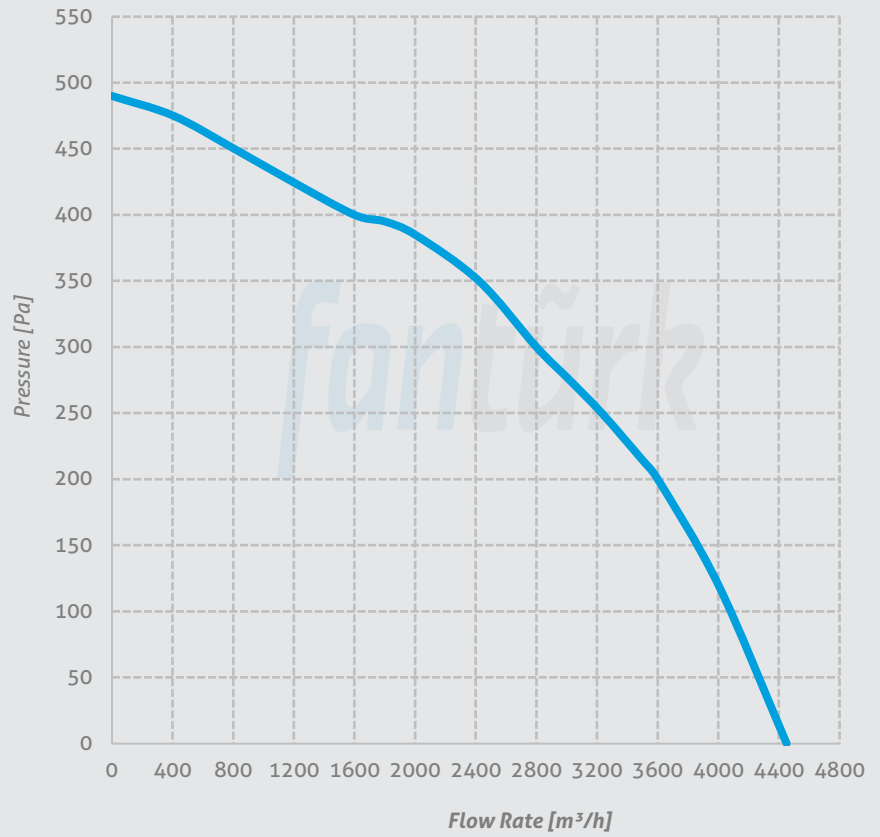

ÇTF-8

Voltage 230 V
Frequency 50 Hz
Current 800 W
Current 3,7 A
Capacitor 16 μ f
Motor Speed 1359 rpm
Flow Rate 6000 m³/h
Sound Pressure Level 62 dBA
Weight 31 kg

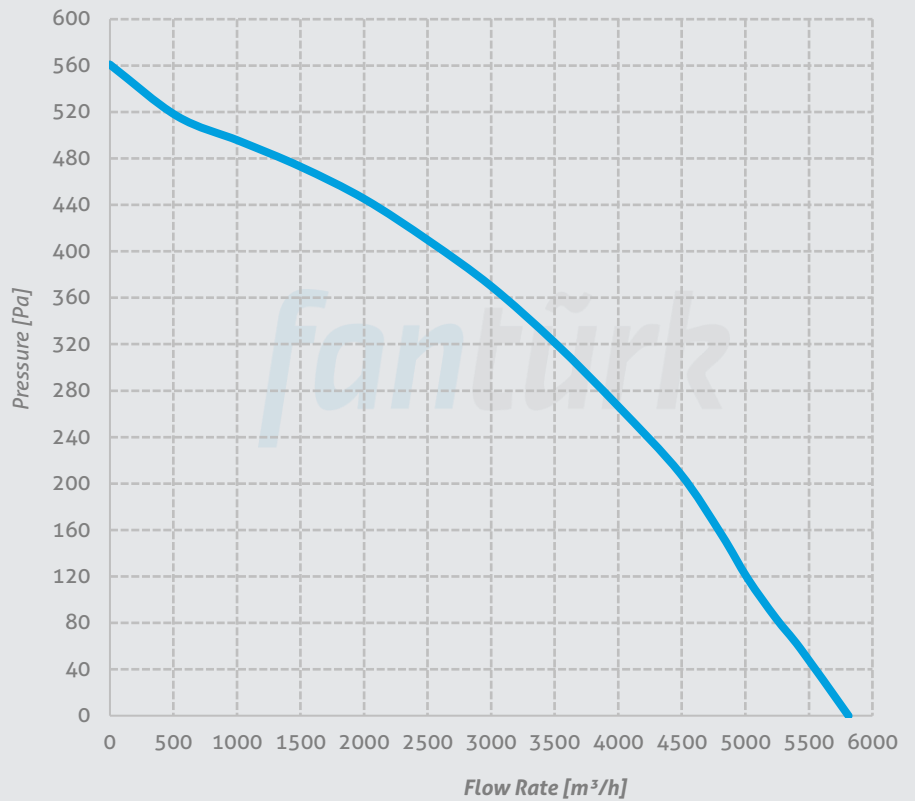

Headquarter: Beşevler Mah. Yıldırım Cad. No336 Nilüfer/Bursa Türkiye

Factory: Pamucak OSB Mah. 2. Cadde No: 14 Pazaryeri/Bilecik Türkiye

T: 90(224)482 2969 E: info@fanturk.com.tr

fanturk.com.tr