



Product Catalogue



ECO Compact Cabinet Type Fan



Technical Specifications

ECO COMPACT CABINET TYPE FAN

ECO series fans are manufactured in high quality with low or high exhaust and fresh air capacity according to the characteristics of the ambient air to be used in order to refresh the ambient air in places where heating and cooling are not desired.

The body is made of high quality corrosion-resistant galvanized steel. The inner skin is completely covered with 6mm rubber insulation. The fans are double inlet radial fans with forward curved blades. The motor is mounted on the fan. The fan driven with pulley-belt system. In this way, the fan speed can be adjusted to meet the operating conditions optimally.

Usage Areas

Can be used for ventilation systems in all kinds of workplaces, offices, cafeterias, markets, restaurants, meeting rooms, shopping malls, hospitals and industrial facilities.

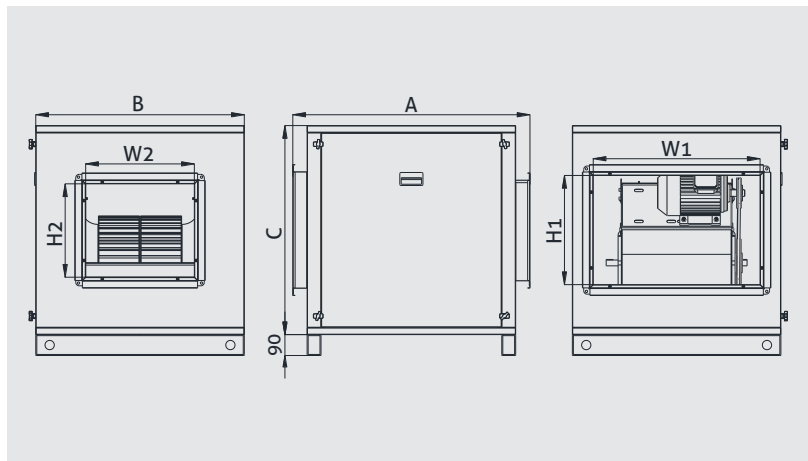
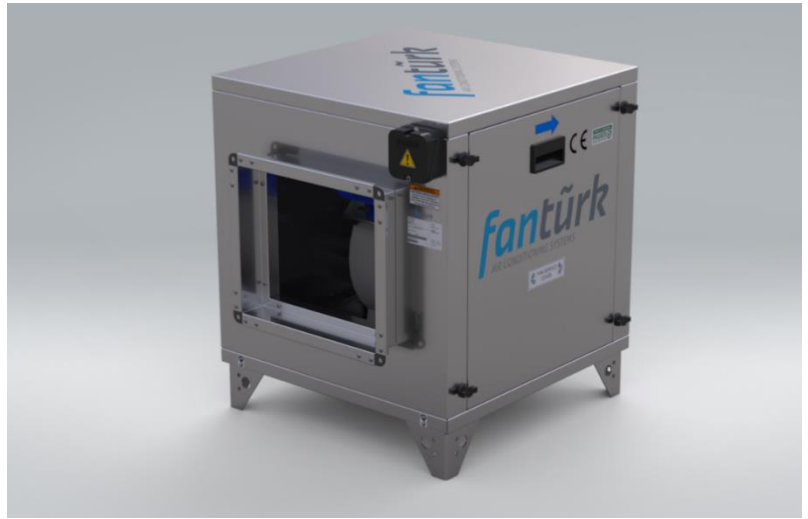

MODEL	A	B	C	Inlet W1xH1	Outlet W2xH2	FLOW RATE	EXTERNAL PRESSURE	STATIC PRESSURE	VOLTAGE	FREQUENCY	MOTOR POWER	MOTOR SPEED	WEIGHT
	mm	mm	mm	mm	mm	m ³ /h	Pa	Pa	V	Hz	kW	rpm	kg
ECO-1	720	600	600	350x300	268x241	2500	270	274	380	50	0,75	1370	43
ECO-2	820	600	600	400x350	336x296	3500	400	406	380	50	1,1	1380	48
ECO-3	920	700	700	500x400	369x325	5000	320	326	380	50	1,5	1385	55
ECO-4	920	800	800	500x500	432x377	7500	300	306	380	50	2,2	1405	65
ECO-5	1020	900	900	750x500	509x439	10000	400	411	380	50	3	1405	80
ECO-6	1170	1050	1050	800x600	592x515	12500	345	355	380	50	3	1405	170
ECO-7	1170	1050	1050	800x600	592x515	15000	294	308	380	50	4	1425	174
ECO-8	1170	1050	1050	800x600	592x515	17500	380	400	380	50	5,5	1430	185

Performance Curves

ECO-1

Flow Rate 2500 m³/h
External Pressure 270 Pa
Static Pressure 274 Pa
Motor Power 0,75 kW
Motor Speed 1370 rpm
Weight 43 kg

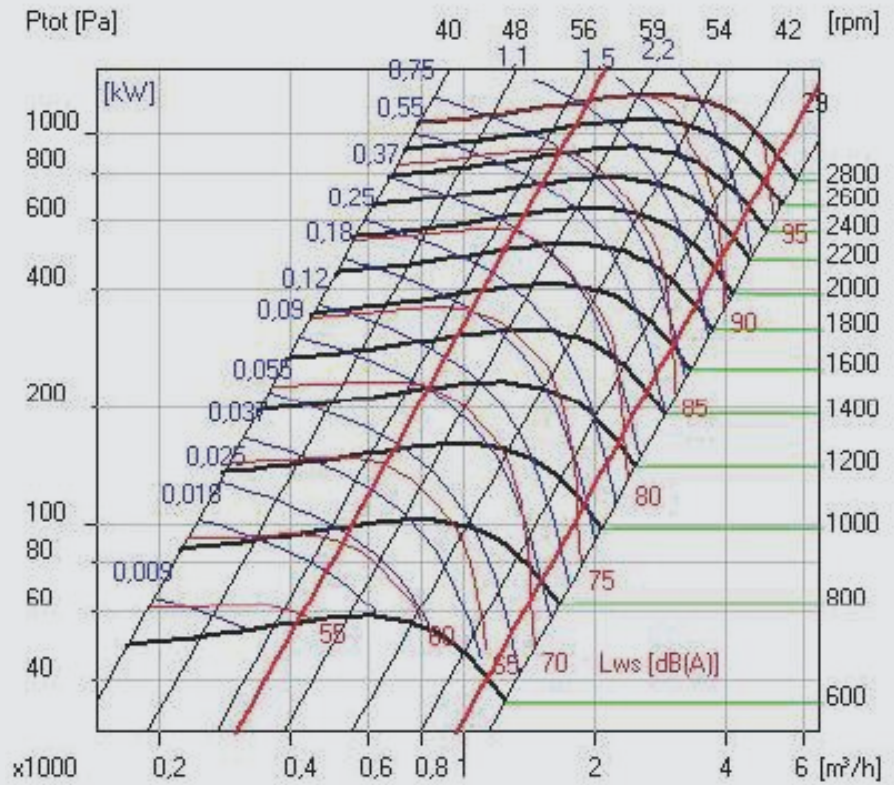

ECO-2

Flow Rate 3500 m³/h
External Pressure 400 Pa
Static Pressure 406 Pa
Motor Power 1,1 kW
Motor Speed 1380 rpm
Weight 48 kg

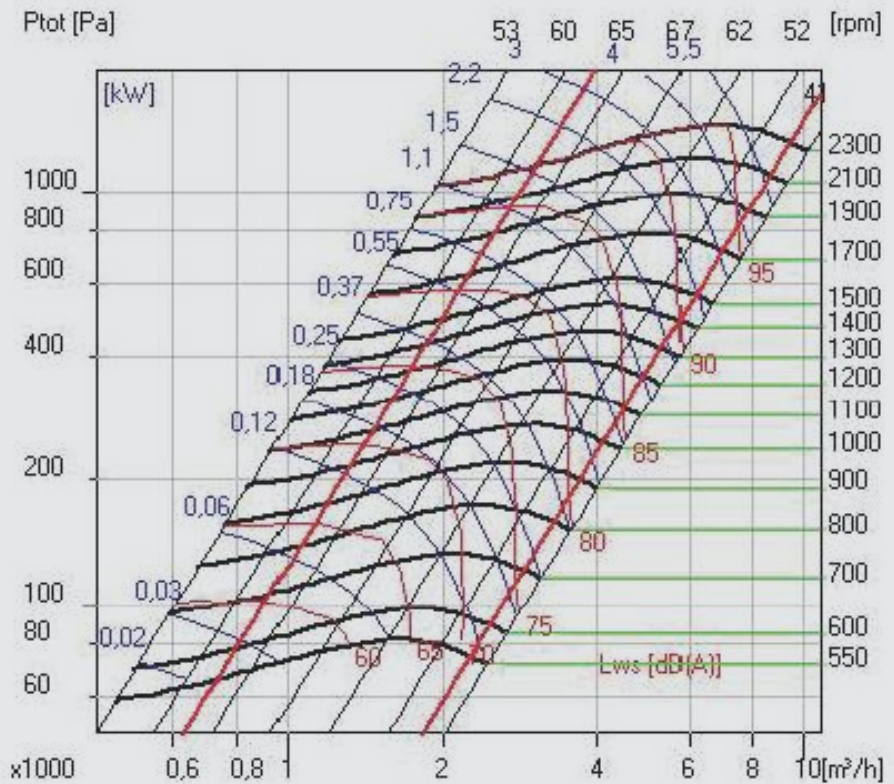

Performance Curves

ECO-3

Flow Rate 5000 m³/h
 External Pressure 320 Pa
 Static Pressure 326 Pa
 Motor Power 1,5 kW
 Motor Speed 1385 rpm
 Weight 55 kg

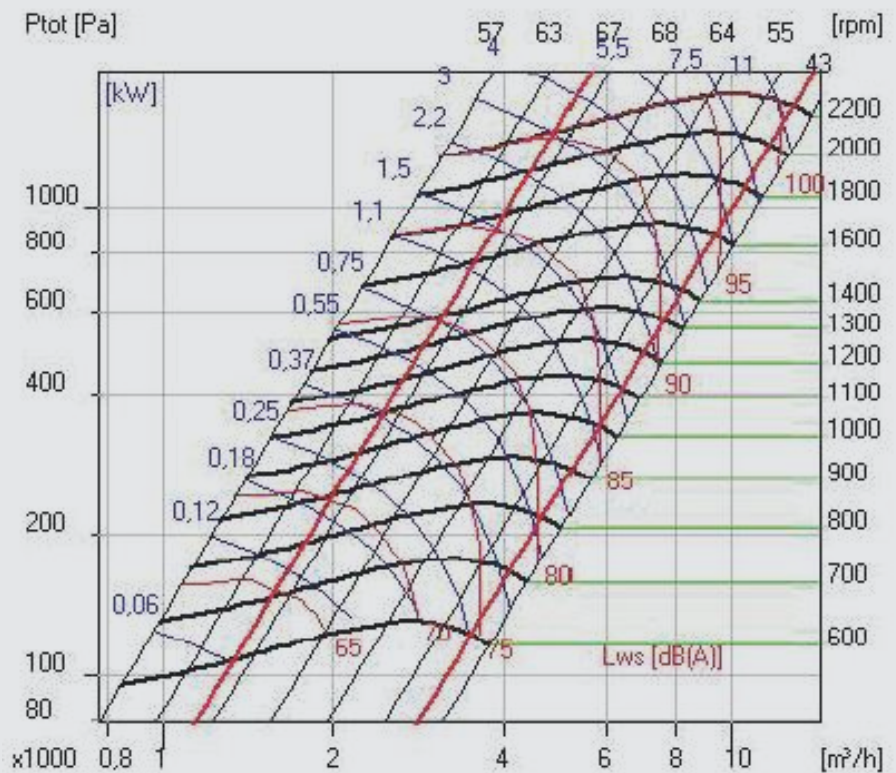

ECO-4

Flow Rate 7500 m³/h
 External Pressure 300 Pa
 Static Pressure 306 Pa
 Motor Power 2,2 kW
 Motor Speed 1405 rpm
 Weight 65 kg

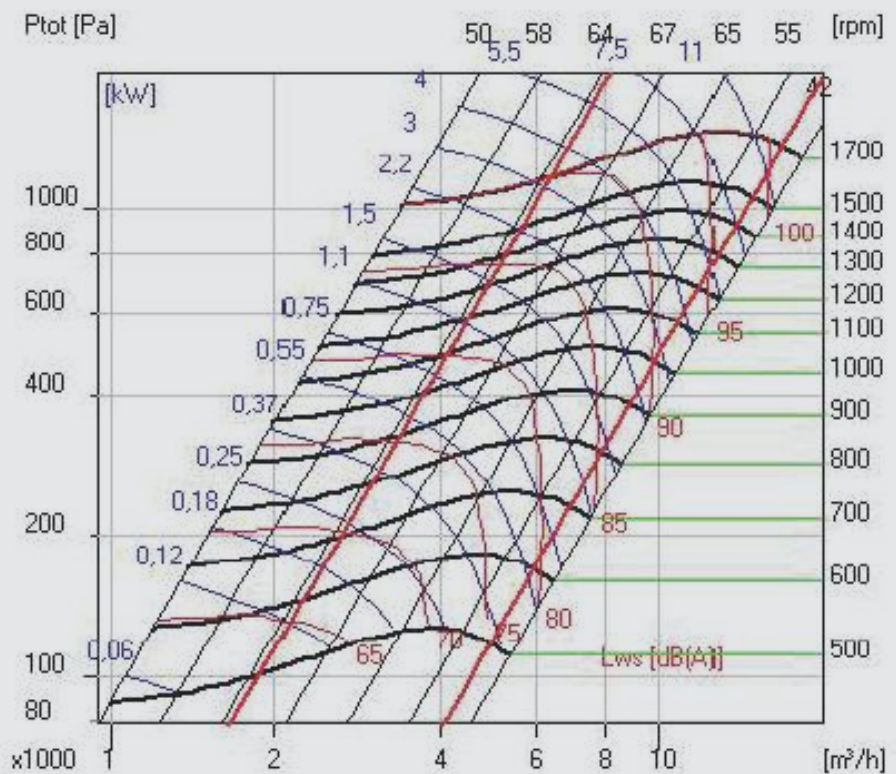

Performance Curves

ECO-5

Flow Rate 10000 m³/h
External Pressure 400 Pa
Static Pressure 411 Pa
Motor Power 3 kW
Motor Speed 1405 rpm
Weight 80 kg

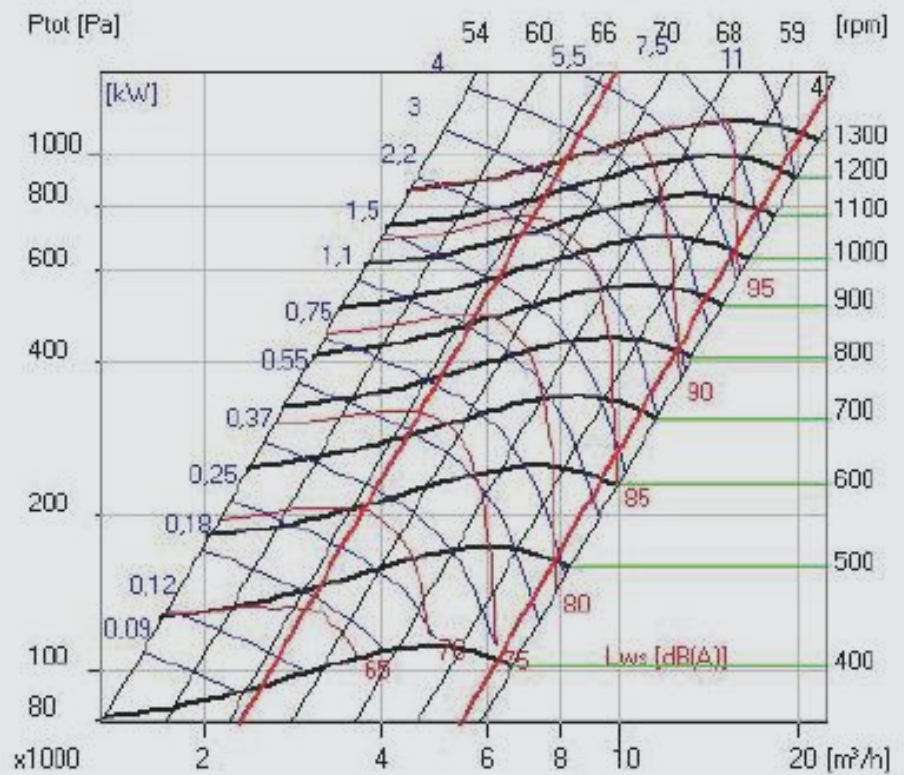

ECO-6

Flow Rate 12500 m³/h
External Pressure 345 Pa
Static Pressure 355 Pa
Motor Power 3 kW
Motor Speed 1405 rpm
Weight 170 kg

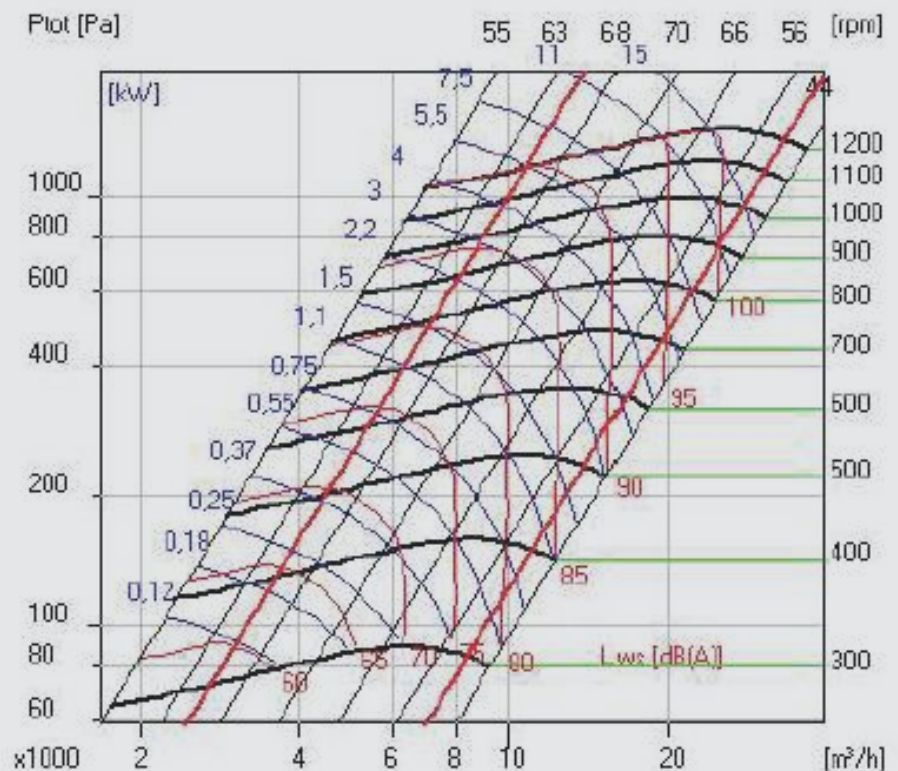

Performance Curves

ECO-7

Flow Rate 15000 m³/h
External Pressure 294 Pa
Static Pressure 308 Pa
Motor Power 4 kW
Motor Speed 1425 rpm
Weight 174 kg

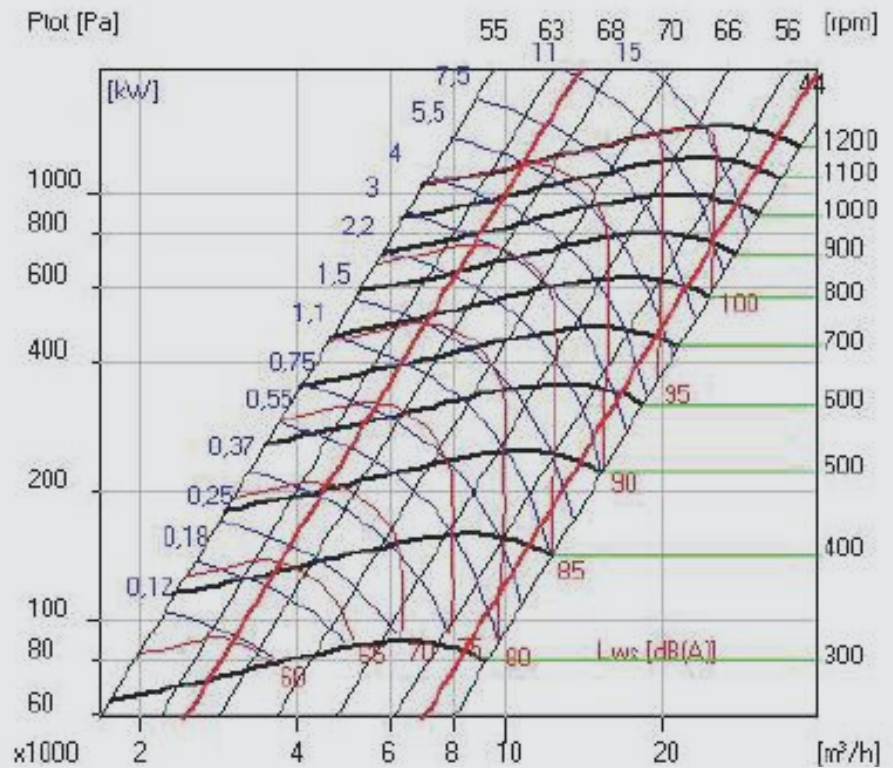

ECO-8

Flow Rate 17500 m³/h
External Pressure 380 Pa
Static Pressure 400 Pa
Motor Power 5,5 kW
Motor Speed 1430 rpm
Weight 185 kg

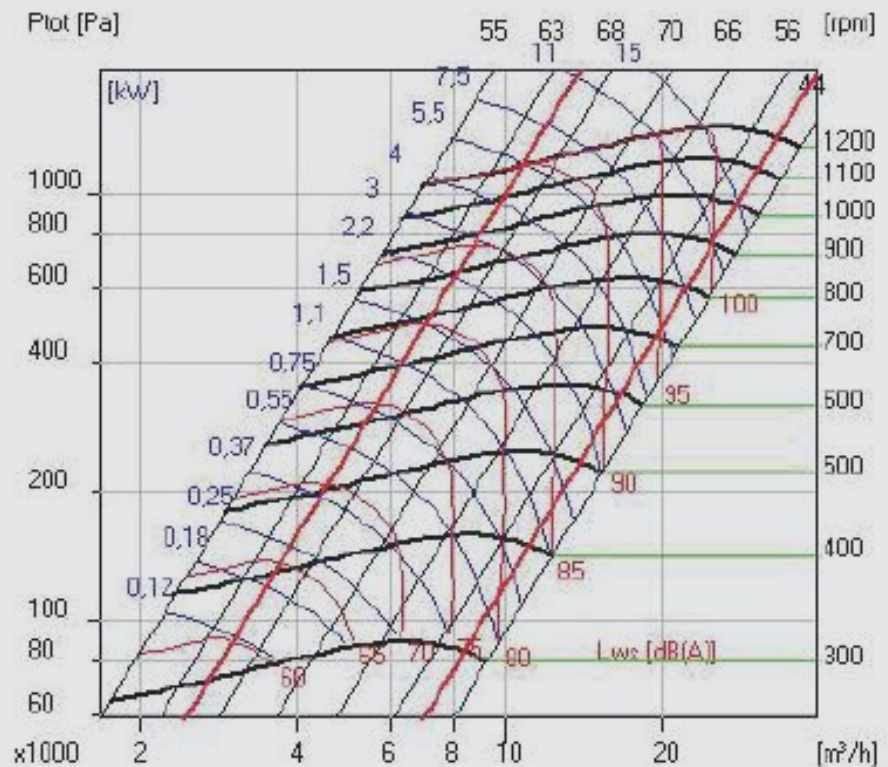

Headquarter: Beşevler Mah. Yıldırım Cad. No336 Nilüfer/Bursa Türkiye

Factory: Pamucak OSB Mah. 2. Cadde No: 14 Pazaryeri/Bilecik Türkiye

T: 90(224)482 2969 E: info@fanturk.com.tr

fanturk.com.tr